



# ISO 20022 Payments

Swiss Implementation Guidelines  
for Customer-Bank Messages  
for Status Report

Customer Payment Status Report (pain.002)



### **General note**

Any suggestions or questions relating to this document should be addressed to the financial institution in question or to SIX Interbank Clearing Ltd at the following address: [pm@six-group.com](mailto:pm@six-group.com).

### **Amendment control**

All the amendments carried out on this document are listed in an amendment record table showing the version, the date of the amendment and a brief amendment description.

### **Change of name from "BC number" (BC No.) to "Institutional identification" (IID)**

The concept of the BC number, short for Bank Clearing Number, has been out-of-date since at least 2010, when the Swiss National Bank provided access to the SIC system also to participants without the status of a bank, such as insurance companies. Furthermore, this number is used not only for the clearing of payments, but also for information that goes beyond the various payment traffic infrastructures. One example is the function of the BC number as part of the IBAN, a form of bank account number that can be used for many purposes.

This is why the Swiss Recommendations will in future use "IID" (institutional identification) instead of "BC no.".

## Amendment control

---

| <i>Version</i> | <i>Date</i> | <i>Amendment description</i>   |
|----------------|-------------|--|
| 1.0            | 25.07.2016  | First edition (separate Implementation Guidelines for Status Report) |

---

## Table of contents

|   |   |           |
|---|---|-----------|
| <b>1</b>  | <b>Introduction .....</b>   | <b>5</b>  |
| 1.1   | Amendment control .....   | 5         |
| 1.2   | Reference documents .....   | 6         |
| 1.3   | Summary of message standards .....  | 7         |
| 1.3.1   | ISO 20022 .....   | 7         |
| 1.3.2   | Swiss ISO 20022 Payments Standard .....                                   | 7         |
| 1.3.3   | SEPA Message Standard .....   | 9         |
| 1.4   | Representation of XML messages .....                                      | 10        |
| 1.5   | XML message conventions .....   | 11        |
| 1.6   | Conventions for presentation .....  | 13        |
| 1.7   | Scope .....   | 14        |
| 1.7.1   | Additional Optional Services (AOS) .....                                  | 14        |
| <b>2</b>  | <b>Customer Payment Status Report (pain.002) .....</b>                    | <b>15</b> |
| 2.1   | General .....   | 15        |
| 2.2   | Technical specifications .....  | 16        |
| 2.2.1   | Group Header (GrpHdr, A-Level) .....                                      | 16        |
| 2.2.2   | Original Group Information And Status (OrgnIGrpInfAndSts, B-Level) .....  | 18        |
| 2.2.3   | Original Payment Information And Status (OrgnPmtInfAndSts, C-Level) ..... | 21        |
| 2.2.4   | Transaction Information And Status (TxInfAndSts, D-Level) .....           | 24        |
| 2.2.5   | Status Reason Codes .....   | 28        |
| 2.3   | Business specifications .....   | 30        |
| 2.3.1   | Status overview in the Status Report .....                                | 30        |
| 2.3.2   | Error messages via Status Report .....                                    | 33        |
| <b>3</b>  | <b>Examples .....</b>   | <b>42</b> |
| <b>Appendix A: XML schema and examples .....</b>                  |   | <b>43</b> |
| <b>Appendix A: Examples Status Reports .....</b>                  |   | <b>44</b> |
| Example 1: Accepted .....   |   | 44        |
| Example 2: Rejected – B-Level .....                               |   | 45        |
| Example 3: Rejected – C-Level .....                               |   | 46        |
| <b>Appendix C: Symbols for graphical XML representation .....</b> |   | <b>47</b> |
| <b>Appendix D: Basis for the Swiss recommendations .....</b>      |   | <b>49</b> |
| <b>Appendix E: Table of tables .....</b>                          |   | <b>50</b> |
| <b>Appendix F: Table of figures .....</b>                         |   | <b>50</b> |

# 1 Introduction

---

The Swiss recommendations for implementing the message standards for Payments Initiation and Cash Management based on ISO standard 20022 have been produced on the instructions of PaCoS (Payments Committee Switzerland), a committee under the Swiss Payments Council (SPC). This version is based on the ISO Maintenance Release 2009 and the latest EPC recommendations.

The Swiss recommendations consist of the following documents:

- Swiss Business Rules
- Swiss Implementation Guidelines
  - for Credit Transfer (pain.001)
  - for the Swiss direct debit procedure (pain.008)
  - for the SEPA direct debit procedure (pain.008)
  - for Cash Management messages (camt.052, camt.053 and camt.054)
  - for Status Report (pain.002) (this document)
- Swiss Usage Guide (use cases and examples)

The first document, the **Business Rules**, describes the requirements of business representatives of users, financial institutions and software providers, from the point of view of processes. It discusses the following subjects:

- Definition and description of specific business transactions, describing the relevant parties and the messages that are used (types of payments, versions of reports)
- Summary of message structures with more detail about certain structural elements
- Description of the main validation rules and ways of handling errors.

The **Implementation Guidelines** serve as manuals for the technical implementation of the standard and provide assistance in producing the various message types. They describe the XML structures and validation rules in detail.

The **Swiss Usage Guide** provides field rules and examples to explain the most frequent use cases (payment types) and explains how ISO 20022 messages (customer-bank or bank-customer) should be structured according to the Swiss recommendations, so providing an end-to-end overview of the whole process.

## 1.1 Amendment control

---

The Swiss Business Rules and Implementation Guidelines documents are subject to the amendment authority of

SIX Interbank Clearing Ltd  
Hardturmstr. 201  
CH-8021 Zurich

and reflect the regulations of Swiss financial institutions. Any future amendments and additions will be made by SIX Interbank Clearing.

The latest version of this document can be downloaded from the SIX Interbank Clearing website at the following address: [www.iso-payments.ch](http://www.iso-payments.ch)

## 1.2 Reference documents

| Ref  | Document                     | Title   | Source                 |
|------|------------------------------|---|------------------------|
| [1]  | Payments Maintenance 2009    | Message Definition Report, Approved by the Payments SEG on 30 March 2009, Edititon September 2009     | ISO                    |
| [2]  | pain.002.001.03              | XML Schema Customer Payment Status Report V03   | ISO                    |
| [3]  | EPC125-05                    | SEPA Credit Transfer Rulebook Version 8.2   | EPC                    |
| [4]  | EPC132-08                    | SEPA Credit Transfer Implementation Guidelines Version 8.0  | EPC                    |
| [5]  | EPC016-06                    | SEPA Core Direct Debit Scheme Rulebook Version 9.2  | EPC                    |
| [6]  | EPC222-07                    | SEPA Business-to-Business Direct Debit Scheme Rulebook Version 7.2                                    | EPC                    |
| [7]  | EPC130-08                    | SEPA Core Direct Debit Customer-to-Bank Implementation Guidelines Version 9.0                         | EPC                    |
| [8]  | EPC131-08                    | SEPA Business-to-Business Direct Debit Scheme Customer-to-Bank Implementation Guidelines Version 7.0  | EPC                    |
| [9]  | Swiss Business Rules         | ISO 20022 Payments – Swiss Business Rules for Payments and Cash Management for Customer-Bank Messages | SIX Interbank Clearing |
| [10] | IG CT                        | Swiss Implementation Guidelines for Customer-Bank Messages Credit Transfer (Payment Transactions)     | SIX Interbank Clearing |
| [11] | IG Swiss-DD                  | Swiss Implementation Guidelines for Customer-Bank Messages for the Swiss direct debit procedure       | SIX Interbank Clearing |
| [12] | IG SDD                       | Swiss Implementation Guidelines for Customer-Bank Messages for the SEPA Direct Debit Scheme           | SIX Interbank Clearing |
| [13] | Payments External Code Lists | Inventory of External Payment Code Lists  | ISO                    |

Table 1: Reference documents

| Organisation           | Link   |
|------------------------|--|
| ISO                    | <a href="http://www.iso20022.org">www.iso20022.org</a>   |
| EPC                    | <a href="http://www.europeanpaymentscouncil.eu">www.europeanpaymentscouncil.eu</a>   |
| SIX Interbank Clearing | <a href="http://www.iso-payments.ch">www.iso-payments.ch</a><br><a href="http://www.sepa.ch">www.sepa.ch</a><br><a href="http://www.six-interbank-clearing.com">www.six-interbank-clearing.com</a> |

Table 2: Links to the relevant Internet pages

## 1.3 Summary of message standards

### 1.3.1 ISO 20022

The ISO 20022 message standard gives details for the following Payment Initiation Messages:

- Customer Credit Transfer Initiation (pain.001) and
- Customer Direct Debit Initiation (pain.008)

Other related messages include, for example:

- Customer Payment Status Report (pain.002)

All these messages are described in the document "ISO 20022 Message Definition Report Payments Standards – Maintenance 2009" [1]. The "pain.007" message is not currently used in Switzerland and is therefore not further discussed here.

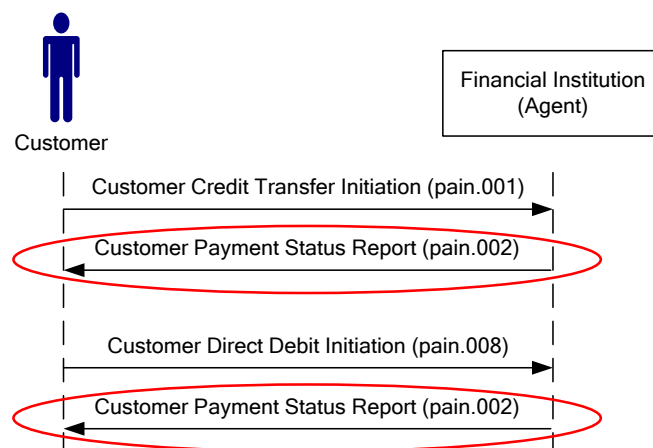

Figure 1: Payment Initiation message flow - summary

The flow of messages is shown in the above Figure 1. The "pain.002" message is sent back to the sender by the recipient of "pain.001" and "pain.008" messages in order to report back the results of validation.

The messages specified in the ISO 20022 standard can be used universally, apply to all currencies and encompass all possible options. The messages are adapted for special areas of use and country-specific circumstances, i.e. not all the options under the standard are used.

### 1.3.2 Swiss ISO 20022 Payments Standard

The message standard recommended by Swiss financial institutions is based on the ISO 20022 standard. In addition to the SEPA Message Standard as described in the EPC Recommendation, all common payment types in national and cross-border transactions are also supported.

The Swiss ISO 20022 Payments Standard encompasses all the data elements that are defined by the EPC in the "SEPA Core Requirements" as being essential, but in some cases has different definitions for the optional data elements, in order to meet the needs of Swiss financial institutions.

The Swiss ISO 20022 Payments Standard is specified in the following documents:

- ISO 20022 Payments: Swiss Business Rules for payments and Cash Management
- ISO 20022 Payments: Swiss Implementation Guidelines for Credit Transfer
- ISO 20022 Payments: Swiss Implementation Guidelines for the SEPA Direct Debit procedure
- ISO 20022 Payments: Swiss Implementation Guidelines for the Swiss Direct Debit procedure
- ISO 20022 Payments: Swiss Implementation Guidelines for Cash Management messages
- ISO 20022 Payments: Swiss Implementation Guidelines for Status Report (this document)

The Swiss Business Rules describe the requirements of business representatives from the point of view of users, financial institutions and software manufacturers with regard to processes.

The Swiss Implementation Guidelines Status Report – this document – contains technical specifications and instructions for the technical and business implementation of the Payment Status Report (Bank-Customer) in accordance with the Swiss ISO 20022 Payments Standard.

Figure 2 below shows the degree of concordance between the Swiss ISO 20022 Payments Standards and ISO 20022 and SEPA.

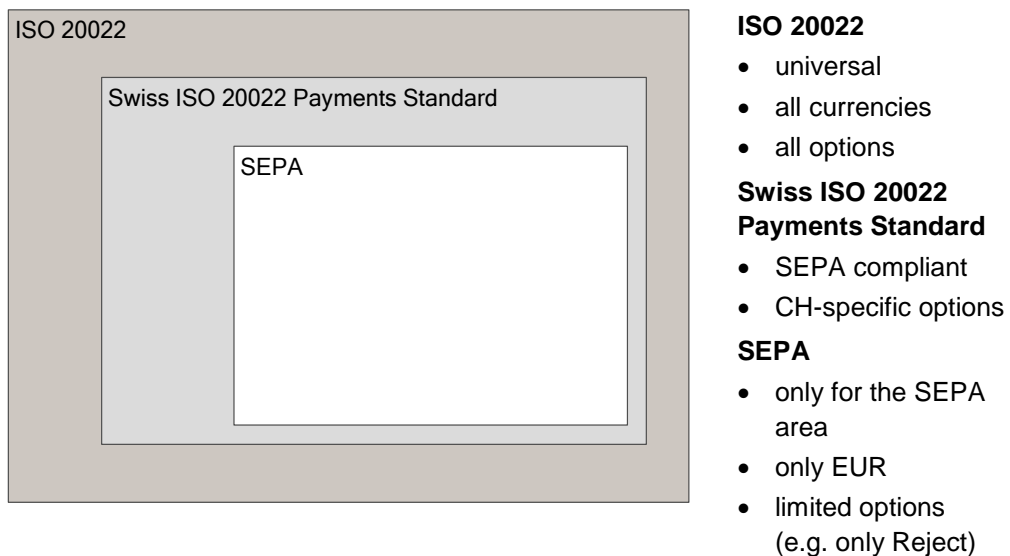

Figure 2: Degree of concordance between the Swiss ISO 20022 Payments Standards and ISO 20022 and SEPA

**Note:** The colours **clay brown** and **light grey** that are used for the ISO 20022 standard and the Swiss ISO 20022 Payments Standard are also used in the column headings of tables in this document.



---

### 1.3.3 SEPA Message Standard

---

For payments in the SEPA area (Single Euro Payments Area), the SEPA Message Standard and the Swiss ISO 20022 Payments Standard are of importance.

In the interests of efficient usage within the SEPA area (EU countries, EEA countries Monaco and Switzerland), some restrictions were applied within the ISO 20022 standard, which were approved by the European Payments Council (EPC), the decision-making body of the European banks and bankers' associations for payment transactions, in November 2009.

The SEPA Message Standard is specified in the following documents published on the website of the European Payments Council (EPC):

- EPC125-05 SEPA Credit Transfer Rulebook [3]
- EPC132-08 SEPA Credit Transfer Implementation Guidelines [4]
- EPC016-06 SEPA Core Direct Debit Scheme Rulebook Version 9.2 [5]
- EPC222-07 SEPA Business-to-Business Direct Debit Scheme Rulebook Version 7.2 [6]
- EPC130-08 SEPA Core Direct Debit Customer-to-Bank Implementation Guidelines Version 9.0 [7]
- EPC131-08 SEPA Business-to-Business Direct Debit Scheme Customer-to-Bank Implementation Guidelines Version 7.0 [8]

## 1.4 Representation of XML messages

The logic structure of XML messages is a tree structure. This can be represented in various ways: in diagrams, tables or text. Representation in text is very suitable for actual examples of messages, while tables and diagrams are mainly suitable for giving an overview of XML schemas. The illustrations in this document are based on the schema in the Swiss recommendations.

XML editors which have the option of graphical representation use symbols which may look slightly different depending on the type of editor (the illustrations in this document were produced using the editor XMLSpy from Altova GmbH). The main symbols are briefly introduced in Appendix C. More detailed information can be found in the user manual or the online help for the XML editor that is being used.

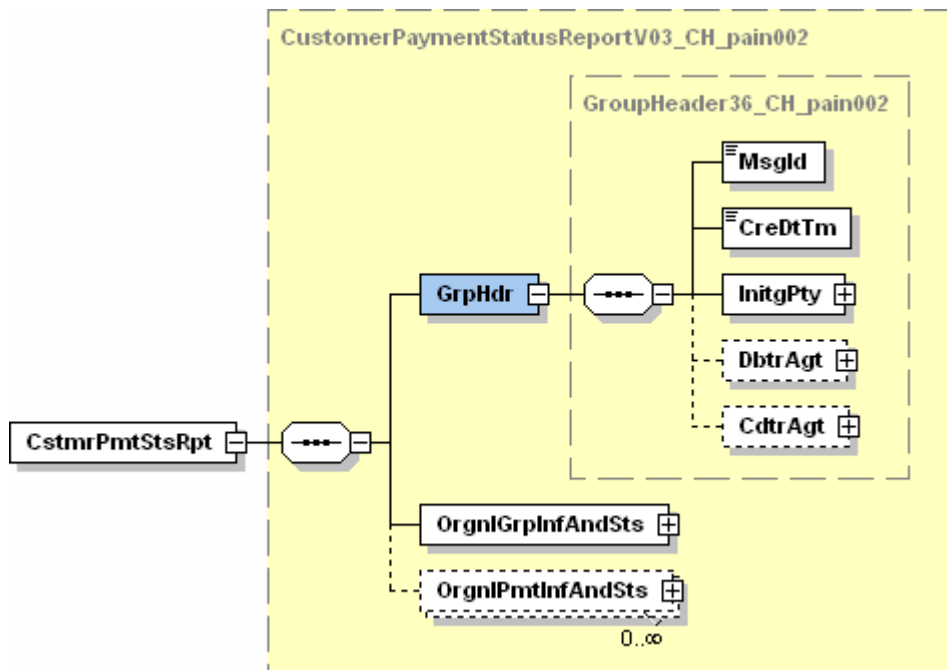

Figure 3: Example of graphical representation of an XML message

## 1.5 XML message conventions

A basic knowledge of XML is assumed for the purposes of this document, so only certain special points are explained.

### Permitted characters

In ISO 20022 XML messages, characters from the Unicode character set UTF-8 (8-Bit Unicode Transformation Format) must always be used (message has to be UTF-8 encoded).

In XML messages under the Swiss ISO 20022 Payments Standard, only the "Latin Character Set" from this is permitted. The characters permitted are specified in the Swiss Implementation Guidelines for Credit Transfer and for Direct Debit procedures.

### Statuses

The following statuses (information about usage) are permitted for individual XML elements according to the Swiss ISO 20022 Payments Standard:

| Status   | Designation | Description   |
|----------|-------------|---|
| <b>M</b> | Mandatory   | The element is mandatory.   |
| <b>R</b> | Recommended | The use of the element is recommended. If the element is not used, the message will normally still be processed by a Swiss bank.                      |
| <b>O</b> | Optional    | The element is optional.  |
| <b>D</b> | Dependent   | The use of the element depends on other elements. Depending on the content or presence of another element, this element may be mandatory or optional. |
| <b>N</b> | Not used    | The element is not supported.   |

### XML schema validation

The technical validation of the various XML messages is carried out using XML schemas. These define the elements that can be used, their status (mandatory, optional, dependent), the format of their content and the content itself (in certain cases the permitted codes are listed in the XML schema). The names of data types given in the tables of this document correspond to the data types defined in XML schemas.

For the Swiss ISO 20022 Payments Standard, its own XML schemas are published as variants of the ISO 20022 XML schemas, in which, for example, unnecessary elements have been omitted or statuses changed. These XML schemas define all the data that is valid for Switzerland. Data types which have been taken over unchanged from the ISO standard retain the same names. For those data types that have been changed, the names have been given appropriate extensions showing the differences between them and the original ISO data types.

Example 1: ISO data type: FinancialInstitutionIdentification7  
 Swiss data type: FinancialInstitutionIdentification7-CH\_BicOrClId

Example 2: ISO data type: PartyIdentification32  
 Swiss data type: PartyIdentification32-CH\_NameAndId

No comments are inserted in the XML schemas. Information about the various data elements can be found in these Implementation Guidelines. In the source text for XML

schemas "pain.001", "pain.008" and "pain.002", XML comments are inserted documenting the differences from the original data type under the ISO standard.

The names of the Swiss ISO 20022 Payments Standard XML schemas and links to the original XSD files are listed in Appendix A.

**Indication of schema location and namespace in XML messages**

The Schema Location in XML messages indicates the XML schema which should be used to carry out the technical validation and where that schema is to be found. The Schema Location also includes the namespace (xmlns="...").

**Using the Swiss XML schema**

The definitions in the Swiss XML schema are the same as the descriptions in these Implementation Guidelines and should primarily be used to validate XML files that have been produced. Submissions can be made either using this Swiss XML schema or the official ISO 20022 XML schema. The XML schema which is to be used must be agreed with the relevant financial institutions.

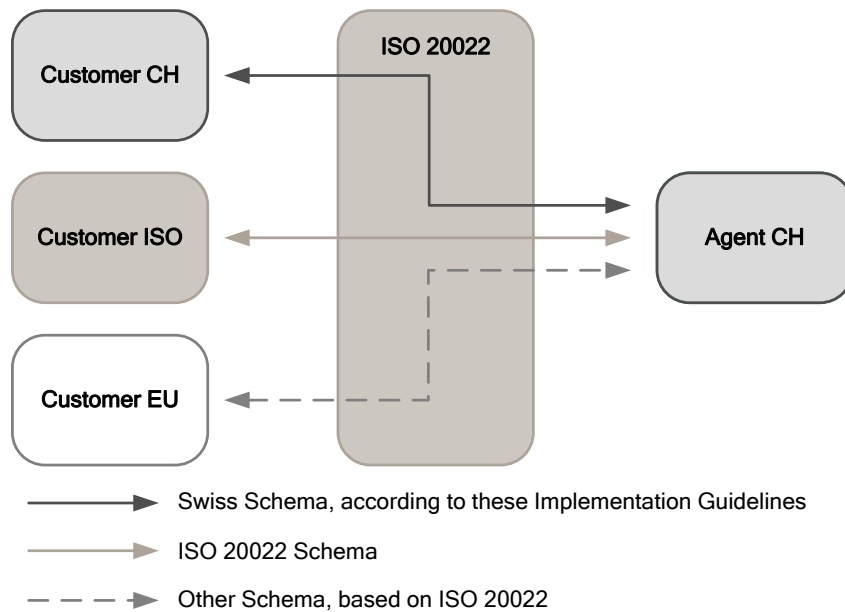

Figure 4: Using the Swiss XML schema

## 1.6 Conventions for presentation

In this document, the following conventions apply to presentation.

### Description of XML elements

In some publications, the names of XML elements are written as a single concept with no spaces, for example CreditTransferTransactionInformation. In the interests of legibility, spaces are generally used in this document.

### Data in tables

The tables contain information from ISO 20022 (Index, Multiplicity, Message Item, XML-Tag). The following information for the Swiss ISO 20022 Payments Standard can also be found in the tables:

- Status of the element (as defined in section 1.5 "XML message conventions")
- General definition

### Colours used in the tables

The column headings are marked in **clay brown** for the information about ISO 20022 and **light grey** for information about the Swiss ISO 20022 Payments Standard.

Elements containing at least one sub-element are marked in **light blue** in the ISO 20022 columns.

### Representation of the tree structure in the tables

So that it is possible to tell where in the tree structure an element comes, the hierarchy level is indicated by preceding "+" signs in the Message Item. For example, the name of the originator is shown as follows in the "Original Group Information And Status" message:

```
Original Group Information And Status
+Status Reason Information
++Originator
+++Name
```

### Representation of choices

Elements with a choice are marked in the "XML Tag" column as follows:

```
{Or   for start of the choice
Or}   for end of the choice
```

Example:

|   |            |      |   |
|---|------------|------|---|
| Group Header<br>+Initiating Party<br>++Identification                                   | Id         | 0..1 | O |
| Group Header<br>+Initiating Party<br>++Identification<br>+++Organisation Identification | OrgId {Or  | 1..1 | D |
| Group Header<br>+Initiating Party<br>++Identification<br>+++Private Identification      | PrvtId Or} | 1..1 | D |

## 1.7 **Scope**

---

These Implementation Guidelines only give the specifications for the customer-bank message "Customer Payment Status Report" for the Swiss ISO 20022 Payments Standard.

No aspects relating to the communication channels used for the sending of messages between customer and financial institution, and their security features, are discussed in this document. These are entirely the responsibility of the financial institutions involved and their customers.

### 1.7.1 **Additional Optional Services (AOS)**

---

- AOS** In general, the recommendations in this document are supported by all Swiss financial institutions. Those services which are not always handled in the same way are identified as "Additional Optional Services" (AOS) and are marked as shown here in the relevant places.

## 2 Customer Payment Status Report (pain.002)

### 2.1 General

The XML message "Customer Payment Status Report" (pain.002) is used by the financial institution to inform customers about the status of "pain.001" transfer orders or "pain.008" collection orders that have been sent. It is used on the basis of the ISO 20022 XML schema "pain.002.001.03".

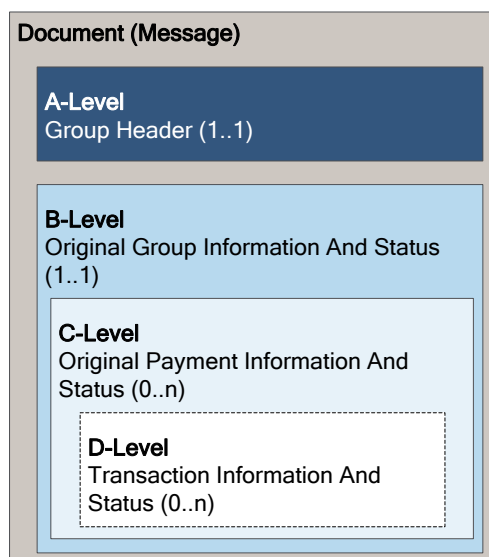

The "pain.002" XML message is essentially structured as follows:

- **A-Level:** message level, "Group Header". This block must occur exactly once.
- **B-Level:** information about the original message level, "Original Group Information And Status". This block must be present exactly once.
- **C-Level:** Information about the original order information, "Original Payment Information And Status". This block can be present up to n times.
- **D-Level:** Information about the original transactions, "Transaction Information And Status". This block can be present up to n times.

Figure 5: Basic message structure for the "pain.002" XML message

In the following **technical specifications** for the XML message "Customer Payment Status Report" (pain.002), each of these message levels is discussed in a separate sub-section:

- 2.2.1 "Group Header (GrpHdr, A-Level)"
- 2.2.2 "Original Group Information And Status (OrgnlGrpInfAndSts, B-Level)"
- 2.2.3 "Original Payment Information And Status (OrgnlPmtInfAndSts, C-Level)"
- 2.2.4 "Transaction Information And Status (TxInfAndSts, D-Level)"

All the possible error messages are listed in section 2.2.5 "Status Reason Codes".

## 2.2 Technical specifications

### 2.2.1 Group Header (GrpHdr, A-Level)

The "Group Header" (A-Level of the message) contains all the elements that apply to all the transactions in the pain.002 "Customer Payment Status Report" XML message. It occurs exactly once in the message.

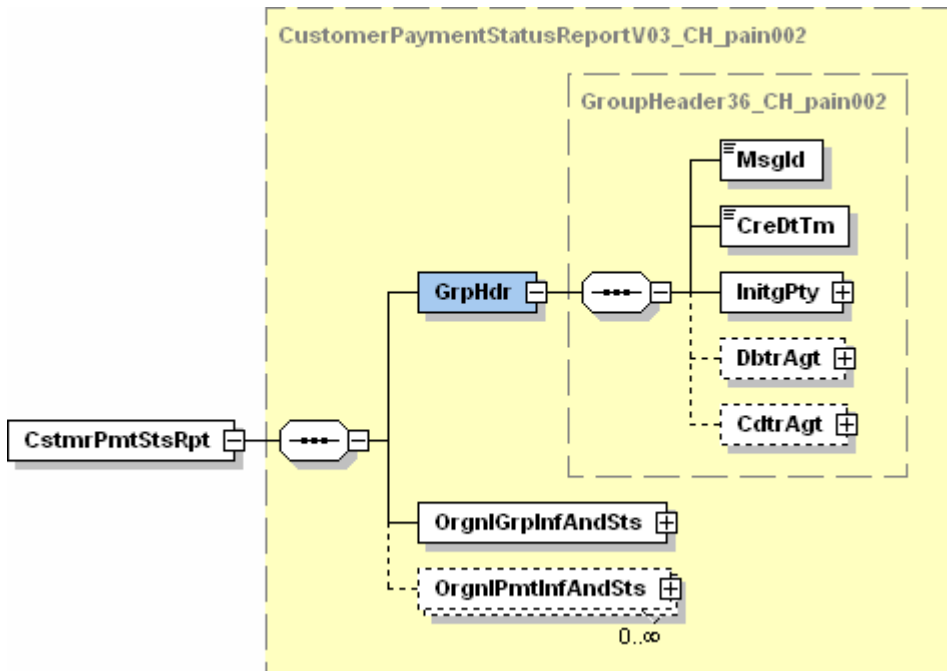

Figure 6: Group Header (GrpHdr)

The following table specifies all the elements of the "Group Header" that are relevant to the Swiss ISO 20022 Payments Standard.

**Note:** The "Customer Payment Status Report" (pain.002) is used both to report back statuses for payment orders (pain.001) and also for collection orders (pain.008) that have been submitted.



| ISO 20022 Standard |   |                |       | Swiss ISO 20022 Payments Standard |   |  |
|--------------------|---|----------------|-------|-----------------------------------|---|--|
| Index              | Message Item  | XML Tag        | Mult. | St.                               | General Definition  |  |
|                    | Document<br>+Customer Payment Status Report V03   | CstmrPmtStsRpt | 1..1  |                                   |   |  |
| 1.0                | Group Header  | GrpHdr         | 1..1  | M                                 |   |  |
| 1.1                | Group Header<br>+Message Identification   | MsgId          | 1..1  | M                                 | Unique message reference, assigned to the message by the sender.  |  |
| 1.2                | Group Header<br>+Creation Date Time   | CreDtTm        | 1..1  | M                                 | Recommendation: Should be the same as the actual date of creation.  |  |
| 1.3                | Group Header<br>+Initiating Party   | InitgPty       | 0..1  | D                                 | Sender of the message<br>One or more sub-elements can be used to give details of the sender.  |  |
| 1.3                | Group Header<br>+Initiating Party<br>++Name   | Nm             | 0..1  | O                                 | Name of the sender of the message, maximum 70 characters  |  |
| 1.3                | Group Header<br>+Initiating Party<br>++Identification                                   | Id             | 0..1  | O                                 | Identification of the sender of the message   |  |
| 1.3                | Group Header<br>+Initiating Party<br>++Identification<br>+++Organisation Identification | OrgId          | 1..1  | D                                 | Only "BIC Or BEI" or an element of "Other" permitted.<br>If used, the "Private Identification" must not be present.   |  |
| 1.3                | Group Header<br>+Initiating Party<br>++Identification<br>+++Private Identification      | PrvtId         | 1..1  | D                                 | Only "Date And Place Of Birth" or an element of "Other" permitted.<br>If used, the "Organisation Identification" must not be present.   |  |
| 1.5                | Group Header<br>+Debtor Agent   | DbtrAgt        | 0..1  | D                                 | Sender of the message<br>Can be used if the "Debtor Agent" is the sender of the message.<br>Only BIC or the IID are permitted under "Clearing System Member Identification/Member Identification".<br><br>Note: Element is only used for Credit Transfer (original message "pain.001"). |  |
| 1.6                | Group Header<br>+Creditor Agent   | CdtrAgt        | 0..1  | D                                 | Sender of the message<br>Can be used if the "Creditor Agent" is the sender of the message.<br>Only BIC or the IID are permitted under "Clearing System Member Identification/Member Identification".<br><br>Note: Element is only used for Direct Debit (original message "pain.008").  |  |

Table 3: Group Header (GrpHdr, A-Level)

**2.2.2 Original Group Information And Status (OrgnlGrplnfAndSts, B-Level)**

The "Original Group Information And Status" (B-Level of the message) occurs in the pain.002 exactly once.

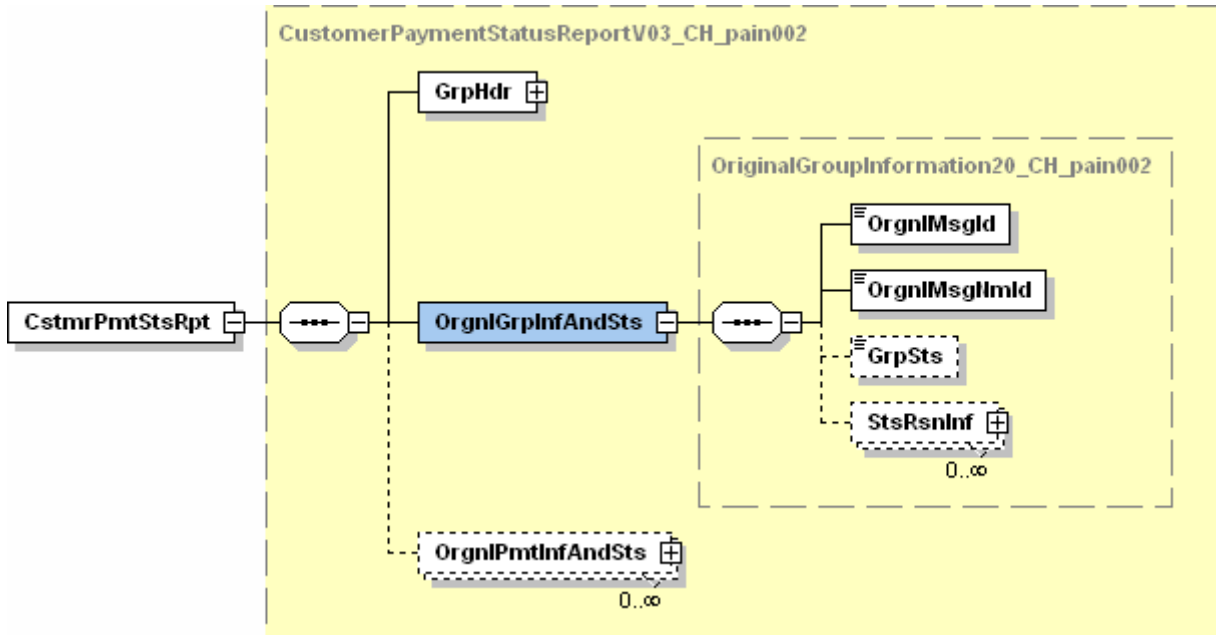

Figure 7: Original Group Information And Status (OrgnlGrplnfAndSts)

The following table specifies all the elements of the "Original Group Information And Status" that are relevant to the Swiss ISO 20022 Payments Standard.

| ISO 20022 Standard |   |                   |       | Swiss ISO 20022 Payments Standard |   |
|--------------------|---|-------------------|-------|-----------------------------------|---|
| Index              | Message Item  | XML Tag           | Mult. | St.                               | General Definition  |
| 2.0                | Original Group Information And Status   | OrgnlGrpInfAndSts | 1..1  | M                                 |   |
| 2.1                | Original Group Information And Status<br>+Original Message Identification   | OrgnlMsgId        | 1..1  | M                                 | "Message Identification" from the original "pain.001" or "pain.008" message.<br>If the message identification could not be identified, then "UNKNOWN" is sent back here.  |
| 2.2                | Original Group Information And Status<br>+Original Message Name Identification  | OrgnlMsgNmId      | 1..1  | M                                 | Name of message "pain.001..." or "pain.008..."<br>If the message could not be identified, then "UNKNOWN" is sent back here.   |
| 2.6                | Original Group Information And Status<br>+Group Status  | GrpSts            | 0..1  | D                                 | The values "ACCP", "ACWC", "PART" and "RJCT" are sent in the status report. Responses of a technical kind may also contain the status "ACTC". Depending on the financial institution and the delivery channel, the "Group Status" may not be required. Deviating from the SEPA recommendations, in Switzerland positive "Group Status" messages are also sent back.   |
| 2.7                | Original Group Information And Status<br>+Status Reason Information   | StsRsnInf         | 0..n  | D                                 | Sent if there are errors/warnings at A-Level.<br>Note:<br><ul style="list-style-type: none"> <li>"Status Reason Information" is used at no more than one level within a message, either in                             <ul style="list-style-type: none"> <li>"Original Group Information And Status" or</li> <li>"Original Payment Information And Status" or</li> <li>"Transaction Information And Status".</li> </ul> </li> <li>If "Group Status" = "ACCP" the "Status Reason Information" is not used.</li> <li>If "Group Status" = "PART" the "Status Reason Information" is used either at the level "Original Payment Information And Status" or "Transaction Information And Status".</li> <li>If "Group Status" = "RJCT" because all B-Levels have been rejected, the "Status Reason Information" is used at the level "Original Payment Information and Status".</li> <li>If "Group Status" = "RJCT" because all C-Levels have been rejected, the "Status Reason Information" is used at the level "Transaction Information And Status".</li> </ul> |
| 2.8                | Original Group Information And Status<br>+Status Reason Information<br>++Originator   | Orgtr             | 0..1  | D                                 | Originator of the status information<br>Can be used if the originator of the status information is not the sender of the message ("Group Header/Initiating Party" or "Group Header/Creditor Agent").  |
| 2.8                | Original Group Information And Status<br>+Status Reason Information<br>++Originator<br>+++Name  | Nm                | 0..1  | D                                 | Name of the originator<br>To be used if no BIC is available.  |
| 2.8                | Original Group Information And Status<br>+Status Reason Information<br>++Originator<br>+++Identification                                    | Id                | 0..1  | D                                 | If this is used, the "Name" must not be present.  |
| 2.8                | Original Group Information And Status<br>+Status Reason Information<br>++Originator<br>+++Identification<br>++++Organisation Identification | OrgId {Or         | 1..1  | M                                 | Must be used if "Identification" is used.   |

| ISO 20022 Standard |   |            |       | Swiss ISO 20022 Payments Standard |   |  |
|--------------------|---|------------|-------|-----------------------------------|---|--|
| Index              | Message Item  | XML Tag    | Mult. | St.                               | General Definition  |  |
| 2.8                | Original Group Information And Status<br>+Status Reason Information<br>++Originator<br>+++Identification<br>++++Organisation Identification<br>+++++BICOr BEI | BICOrBEI   | 0..1  | M                                 | BIC of the originator   |  |
| 2.8                | Original Group Information And Status<br>+Status Reason Information<br>++Originator<br>+++Identification<br>++++Private Identification                        | PrvtId Or} | 1..1  | N                                 |   |  |
| 2.9                | Original Group Information And Status<br>+Status Reason Information<br>++Reason   | Rsn        | 0..1  | M                                 | Reason for the status   |  |
| 2.10               | Original Group Information And Status<br>+Status Reason Information<br>++Reason<br>+++Code  | Cd {Or     | 1..1  | D                                 | Code as described in section "Status Reason Codes"<br>If used, then "Proprietary" must not be present.                                      |  |
| 2.11               | Original Group Information And Status<br>+Status Reason Information<br>++Reason<br>+++Proprietary   | Prtry Or}  | 1..1  | D                                 | Swiss financial institutions will, wherever possible, abide by ISO standards ("Code" element).<br>If used, then "Code" must not be present. |  |
| 2.12               | Original Group Information And Status<br>+Status Reason Information<br>++Additional Information   | AddlInf    | 0..n  | O                                 | Can be used optionally to provide additional information about the "Reason".  |  |

Table 4: Original Group Information And Status (OrgnlGrpInfAndSts, B-Level)

### 2.2.3 Original Payment Information And Status (OrgnPmtInfAndSts, C-Level)

The "Original Payment Information And Status" (C-Level of the message) can occur once or more than once in the "pain.002" message.

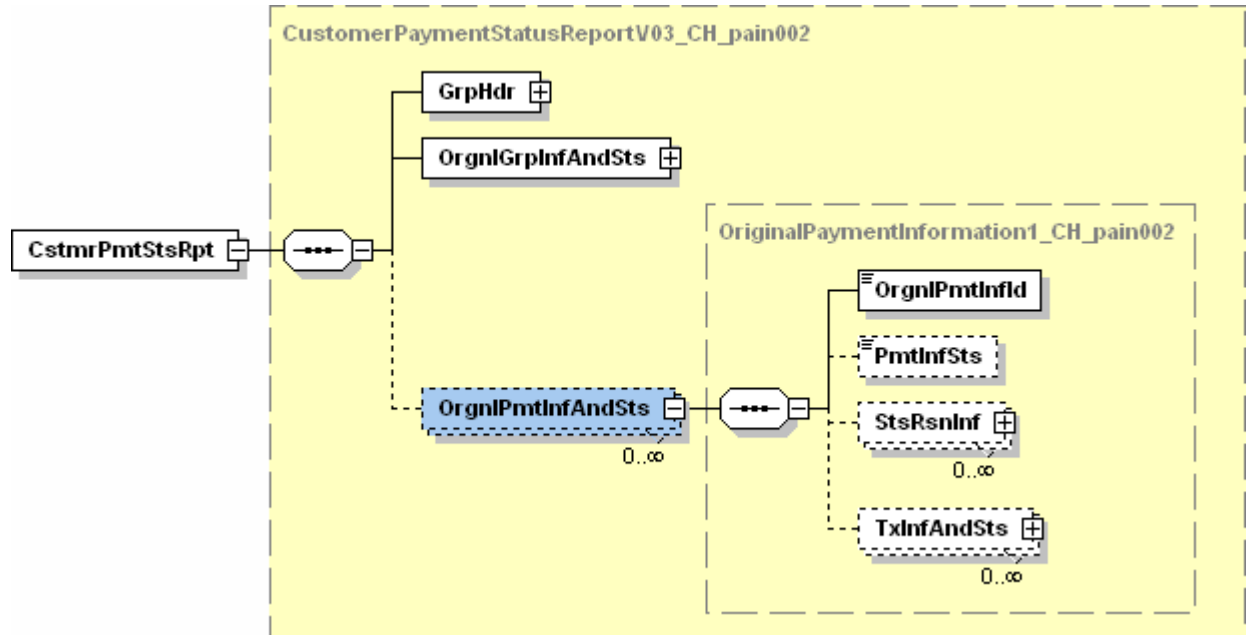

Figure 8: Original Payment Information And Status (OrgnPmtInfAndSts)

The following table specifies all the elements of the "Original Payment Information And Status" that are relevant to the Swiss ISO 20022 Payments Standard.

| ISO 20022 Standard |  |                   |       | Swiss ISO 20022 Payments Standard |   |
|--------------------|--|-------------------|-------|-----------------------------------|---|
| Index              | Message Item   | XML Tag           | Mult. | St.                               | General Definition  |
| 3.0                | Original Payment Information And Status  | OrgnlPmtInfAndSts | 0..n  | D                                 | Is sent if there are errors/warnings at B-/C-Level of the original "pain.001" or "pain.008" message.  |
| 3.1                | Original Payment Information And Status<br>+Original Payment Information Identification  | OrgnlPmtInfId     | 1..1  | M                                 | "Payment Information Identification" (B-Level) from the original "pain.001" or "pain.008" message (or "NOTPROVIDED"). Is always sent if there are errors/warnings at B- or C-Level.   |
| 3.4                | Original Payment Information And Status<br>+Payment Information Status   | PmtInfSts         | 0..1  | D                                 | This element is sent if there are errors/warnings at B-Level of the order (pain.001/pain.008). Only "ACWC", "PART", "RJCT" are sent, no other interim status. Deviating from SEPA, positive "Payment Information-Status" messages are also sent back.<br>Additional status messages may include other values, such as "ACTC" for instance (after a purely technical validation of the received message) or "ACCP" (status message due to a status change of an order or as a response to individual B-Levels).  |
| 3.5                | Original Payment Information And Status<br>+Status Reason Information  | StsRsnInf         | 0..n  | D                                 | Is sent if there are errors/warnings at B-Level.<br>Note:<br>• "Status Reason Information" is used at no more than one level within a message, either in<br>- "Original Group Information And Status" or<br>- "Original Payment Information And Status" or<br>- "Transaction Information And Status".<br>• If "PmtInfSts" = "ACWC" because warnings at C-Level have occurred, the "Status Reason Information" is used at the level "Transaction Information And Status".<br>• If "PmtInfSts" = "PART" the "Status Reason Information" is used at the level "Transaction Information And Status".<br>• If "PmtInfSts" = "RJCT" because all C-Levels have been rejected, the "Status Reason Information" is used at the level "Transaction Information And Status". |
| 3.6                | Original Payment Information And Status<br>+Status Reason Information<br>++Originator  | Orgtr             | 0..1  | D                                 | Originator of the status information<br>Can be used if the originator of the status information is not the sender of the message ("Group Header/Initiating Party" or "Group Header/Creditor Agent").  |
| 3.6                | Original Payment Information And Status<br>+Status Reason Information<br>++Originator<br>+++Name   | Nm                | 0..1  | D                                 | Name of the originator<br>To be used if no "BIC/BEI" is available.<br>If this is used, the "Identification" must not be present.  |
| 3.6                | Original Payment Information And Status<br>+Status Reason Information<br>++Originator<br>+++Identification   | Id                | 0..1  | D                                 | If this is used, the "Name" must not be present.  |
| 3.6                | Original Payment Information And Status<br>+Status Reason Information<br>++Originator<br>+++Identification<br>++++Organisation Identification                    | OrgId {Or         | 1..1  | M                                 | Must be used if "Identification" is used.   |
| 3.6                | Original Payment Information And Status<br>+Status Reason Information<br>++Originator<br>+++Identification<br>++++Organisation Identification<br>+++++BIC Or BEI | BICOrBEI          | 0..1  | M                                 | BIC/BEI of the originator<br>Must be used if "Identification" is used.  |

| ISO 20022 Standard |  |                   |       | Swiss ISO 20022 Payments Standard |   |  |
|--------------------|--|-------------------|-------|-----------------------------------|---|--|
| Index              | Message Item   | XML Tag           | Mult. | St.                               | General Definition  |  |
| 3.6                | Original Payment Information And Status<br>+Status Reason Information<br>++Originator<br>+++Identification<br>++++Private Identification | PrvtId<br><br>Or} | 1..1  | N                                 |   |  |
| 3.7                | Original Payment Information And Status<br>+Status Reason Information<br>++Reason  | Rsn               | 0..1  | M                                 | Reason for the status<br>Must be used if "Status Reason Information" is used.   |  |
| 3.8                | Original Payment Information And Status<br>+Status Reason Information<br>++Reason<br>+++Code   | Cd<br><br>{Or     | 1..1  | D                                 | Code as described in section "Status Reason Codes"<br>If this is used, "Proprietary" must not be present.                                   |  |
| 3.9                | Original Payment Information And Status<br>+Status Reason Information<br>++Reason<br>+++Proprietary                                      | Prtry<br><br>Or}  | 1..1  | D                                 | Swiss financial institutions will, wherever possible, abide by ISO standards ("Code" element).<br>If used, then "Code" must not be present. |  |
| 3.10               | Original Payment Information And Status<br>+Status Reason Information<br>++Additional Information  | AddtlInf          | 0..n  | O                                 | Can be used optionally to provide additional information about the "Reason".  |  |

Table 5: Original Payment Information and Status (OrgnIPmtInfAndSts, C-Level)

**2.2.4 Transaction Information And Status (TxInfAndSts, D-Level)**

The "Transaction Information And Status" (D-Level of the message) can occur once or more than once in the "pain.002" message.

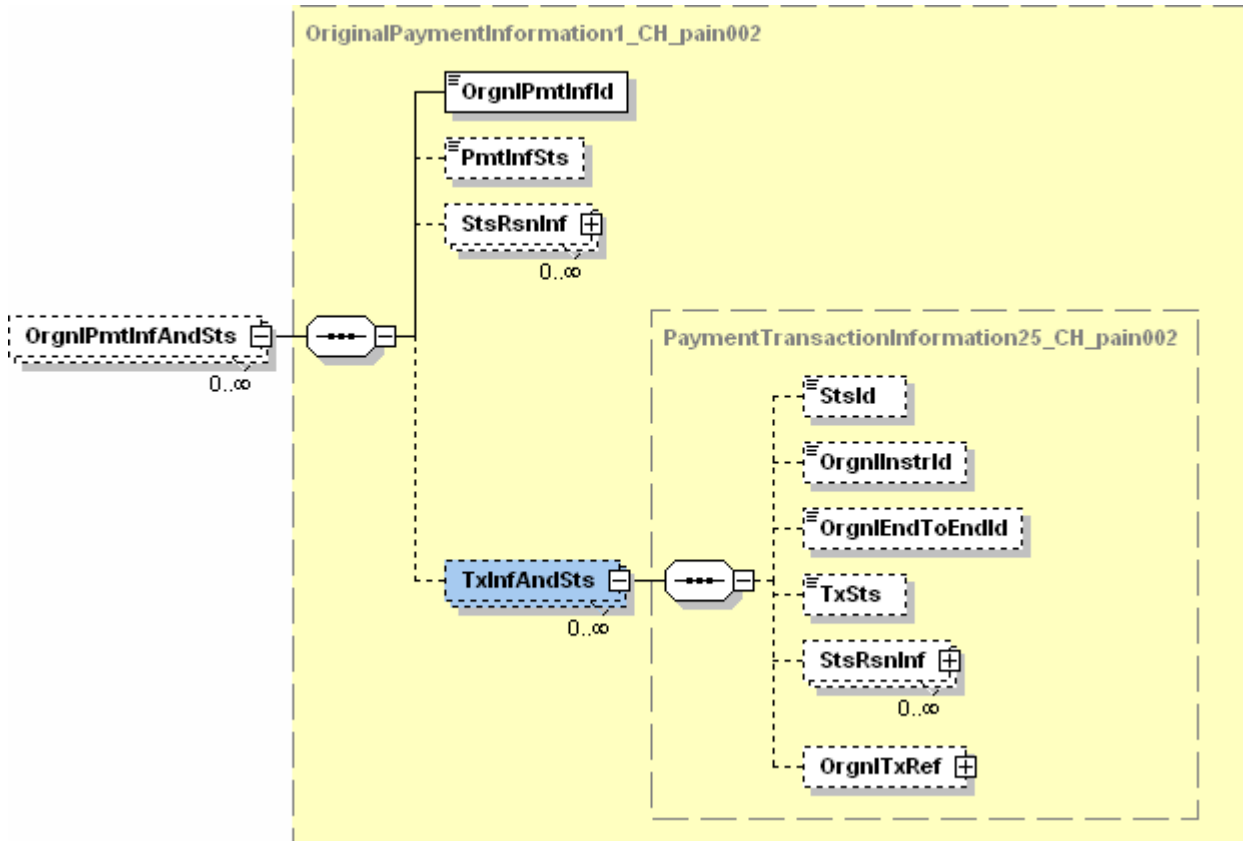

Figure 9: Transaction Information And Status (TxInfAndSts)

The following table specifies all the elements of the "Transaction Information And Status" that are relevant to the Swiss ISO 20022 Payments Standard.



| ISO 20022 Standard |  |                 |       | Swiss ISO 20022 Payments Standard |  |   |
|--------------------|--|-----------------|-------|-----------------------------------|--|---|
| Index              | Message Item   | XML Tag         | Mult. | St.                               | General Definition   |   |
| 3.15               | Transaction Information And Status   | TxInfAndSts     | 0..n  | D                                 | Is sent if there are errors/warnings at C-Level of the original "pain.001" or "pain.008" message.  |   |
| 3.16               | Transaction Information And Status<br>+Status Identification   | StsId           | 0..1  | O                                 | Unique identification, set by the originator of this message.  |   |
| 3.17               | Transaction Information And Status<br>+Original Instruction Identification   | OrgnlInstrId    | 0..1  | D                                 | "Instruction Identification" (C-Level) from the original message. Is always sent if there are errors/warnings at C-Level (if not available, then "NOTPROVIDED" is sent).   |   |
| 3.18               | Transaction Information And Status<br>+Original End To End Identification  | OrgnlEndToEndId | 0..1  | D                                 | "End To End Identification" (C-Level) from the original message. Is always sent if there are errors/warnings at C-Level (if not available or empty, then "NOTPROVIDED" is sent).   |   |
| 3.19               | Transaction Information And Status<br>+Transaction Status  | TxSts           | 0..1  | D                                 | Is sent if there are errors/warnings at C-Level. Only "ACWC" and "RJCT" are sent, no other interim status. "ACCP" is not sent explicitly.  |   |
| 3.20               | Transaction Information And Status<br>+Status Reason Information   | StsRsnInf       | 0..n  | D                                 | Is sent if there are errors/warnings at C-Level.<br>Note: "Status Reason Information" is used at no more than one level within a message, either in<br>- "Original Group Information And Status" or<br>- "Original Payment Information And Status" or<br>- "Transaction Information And Status". |   |
| 3.21               | Transaction Information And Status<br>+Status Reason Information<br>++Originator   | Orgtr           | 0..1  | D                                 | Originator of the status information<br>Can be used if the originator of the status information is not the sender of the message ("Group Header/Initiating Party" or "Group Header/Creditor Agent").   |   |
| 3.21               | Transaction Information And Status<br>+Status Reason Information<br>++Originator<br>+++Name  | Nm              | 0..1  | D                                 | Name of the originator<br>To be used if no "BIC/BEI" is available.<br>If this is used, the "Identification" must not be present.   |   |
| 3.21               | Transaction Information And Status<br>+Status Reason Information<br>++Originator<br>+++Identification  | Id              | 0..1  | D                                 | If this is used, the "Name" must not be present.   |   |
| 3.21               | Transaction Information And Status<br>+Status Reason Information<br>++Originator<br>+++Identification<br>++++Organisation Identification                   | OrgId           | {Or}  | 1..1                              | M  | Must be used if "Identification" is used. |
| 3.21               | Transaction Information And Status<br>+Status Reason Information<br>++Originator<br>+++Identification<br>++++Organisation Identification<br>+++++BICOr BEI | BICOrBEI        | 0..1  | M                                 | BIC/BEI of the originator<br>Must be used if "Identification" is used.   |   |
| 3.21               | Transaction Information And Status<br>+Status Reason Information<br>++Originator<br>+++Identification<br>++++Private Identification                        | PrvtId          | Or}   | 1..1                              | N  |   |

| ISO 20022 Standard |   |               |             | Swiss ISO 20022 Payments Standard |  |
|--------------------|---|---------------|-------------|-----------------------------------|--|
| Index              | Message Item  | XML Tag       | Mult.       | St.                               | General Definition   |
| 3.22               | Transaction Information And Status<br>+Status Reason Information<br>++Reason                              | Rsn           | 0..1        | M                                 | Reason for the status<br>Must be used if "Status Reason Information" is used.  |
| 3.23               | Transaction Information And Status<br>+Status Reason Information<br>++Reason<br>+++Code                   | Cd            | {Or<br>1..1 | D                                 | Code as described in section "Status Reason Codes"<br>If this is used, "Proprietary" must not be present.  |
| 3.24               | Transaction Information And Status<br>+Status Reason Information<br>++Reason<br>+++Proprietary            | Prtry         | Or}<br>1..1 | D                                 | Swiss financial institutions will, wherever possible, abide by ISO standards ("Code" element).<br>If used, then "Code" must not be present.                            |
| 3.25               | Transaction Information And Status<br>+Status Reason Information<br>++Additional Information              | AddlInf       | 0..n        | O                                 | Can be used optionally to provide additional information about the "Status Reason".  |
| 3.32               | Transaction Information And Status<br>+Original Transaction Reference                                     | OrgnlTxRef    | 0..1        | D                                 | Original elements from the original message<br>Generally only those elements are sent back which caused warnings or errors. Optionally, other fields can be sent back. |
| 3.34               | Transaction Information And Status<br>+Original Transaction Reference<br>++Amount                         | Amt           | 0..1        | O                                 | Information from the original message  |
| 3.39               | Transaction Information And Status<br>+Original Transaction Reference<br>++Interbank Settlement Date      | IntrBkSttlmDt | 0..1        | D                                 | Effective settlement date<br>Sent if the required settlement date has been set for the next banking business/Post Office working day.                                  |
| 3.40               | Transaction Information And Status<br>+Original Transaction Reference<br>++Requested Collection Date      | ReqdColltnDt  | 0..1        | O                                 | Information from the original message<br>Element is only used for Direct Debit (original message "pain.008").  |
| 3.41               | Transaction Information And Status<br>+Original Transaction Reference<br>++Requested Execution Date       | ReqdExctnDt   | 0..1        | O                                 | Information from the original message<br>Element is only used for Credit Transfer (original message "pain.001").   |
| 3.42               | Transaction Information And Status<br>+Original Transaction Reference<br>++Creditor Scheme Identification | CdtrSchmeld   | 0..1        | O                                 | Information from the original message<br>Element is only used for Direct Debit (original message "pain.008").  |
| 3.55               | Transaction Information And Status<br>+Original Transaction Reference<br>++Payment Type Information       | PmtTpInf      | 0..1        | O                                 | Information from the original message  |
| 3.68               | Transaction Information And Status<br>+Original Transaction Reference<br>++Payment Method                 | PmtMtd        | 0..1        | O                                 | Information from the original message  |
| 3.69               | Transaction Information And Status<br>+Original Transaction Reference<br>++Mandate Related Information    | MndtRltdInf   | 0..1        | O                                 | Information from the original message<br>Element is only used for Direct Debit (original message "pain.008").  |

| ISO 20022 Standard |   |           |       | Swiss ISO 20022 Payments Standard |                                       |  |
|--------------------|---|-----------|-------|-----------------------------------|---------------------------------------|--|
| Index              | Message Item  | XML Tag   | Mult. | St.                               | General Definition                    |  |
| 3.88               | Transaction Information And Status<br>+Original Transaction Reference<br>++Remittance Information | RmtInf    | 0..1  | O                                 | Information from the original message |  |
| 3.120              | Transaction Information And Status<br>+Original Transaction Reference<br>++Ultimate Debtor        | UltmtDbtr | 0..1  | O                                 | Information from the original message |  |
| 3.121              | Transaction Information And Status<br>+Original Transaction Reference<br>++Debtor                 | Dbtr      | 0..1  | O                                 | Information from the original message |  |
| 3.122              | Transaction Information And Status<br>+Original Transaction Reference<br>++Debtor Account         | DbtrAcct  | 0..1  | O                                 | Information from the original message |  |
| 3.123              | Transaction Information And Status<br>+Original Transaction Reference<br>++Debtor Agent           | DbtrAgt   | 0..1  | O                                 | Information from the original message |  |
| 3.125              | Transaction Information And Status<br>+Original Transaction Reference<br>++Creditor Agent         | CdtrAgt   | 0..1  | O                                 | Information from the original message |  |
| 3.127              | Transaction Information And Status<br>+Original Transaction Reference<br>++Creditor               | Cdtr      | 0..1  | O                                 | Information from the original message |  |
| 3.128              | Transaction Information And Status<br>+Original Transaction Reference<br>++Creditor Account       | CdtrAcct  | 0..1  | O                                 | Information from the original message |  |
| 3.129              | Transaction Information And Status<br>+Original Transaction Reference<br>++Ultimate Creditor      | UltmtCdtr | 0..1  | O                                 | Information from the original message |  |

Table 6: Transaction Information And Status (TxInfAndSts, D-Level)

**2.2.5 Status Reason Codes**

The reason for the rejection or information about modifications to data are given in the "Status Reason Code" element. For this purpose, financial institutions use, wherever possible, the ISO Code.

**ISO Code**

In principle, all values from the Payments External Code Lists [13] (see "ExternalStatus Reason1Code") can be used.

The ISO code values used in these Swiss Implementation Guidelines for which there are also Swiss code values are listed in the following table and are used in the "Code" element (codes shaded in gray are only used for Swiss Direct Debit and/or for SEPA Direct Debit, codes shaded in light blue only for Credit Transfers).

| ISO Code | Error  |
|----------|--|
| AC01     | Incorrect account number   |
| AGNT     | Incorrect agent  |
| AM01     | Specified message amount is equal to zero  |
| AM02     | Not allowed amount   |
| AM03     | Not allowed currency   |
| AM10     | Invalid control sum  |
| AM18     | Invalid number of transactions   |
| BE01     | Identification of end customer is not consistent with associated account number  |
| BE09     | Country code is missing or invalid   |
| CH03     | Value in Requested Execution Date or Requested Collection Date is too far in the future  |
| CH04     | Value in Requested Execution Date or Requested Collection Date is too far in the past  |
| CH07     | Element is not to be used at B- and C-Level  |
| CH09     | Mandate changes are not allowed  |
| CH10     | Information on mandate changes are missing   |
| CH11     | Value in Creditor Identifier is incorrect  |
| CH12     | Element Creditor Identifier is not unambiguously at B-Level (SEPA Direct Debit only)   |
| CH14     | Element Original Debtor Account is not to be used (SEPA Direct Debit only)   |
| CH15     | Element content includes more than 140 characters  |
| CH16     | Element content formally incorrect   |
| CH17     | Element not admitted   |
| CH19     | Values in Interbank Settlement Date or Requested Collection Date will be set to the next banking business day or TARGET day (SEPA Direct Debit only) |
| CH20     | Decimal points not compatible with currency  |
| CH21     | Required compulsory element missing  |
| CH22     | CORE and B2B not permitted within one message (SEPA Direct Debit only)   |
| CURR     | Incorrect currency   |
| DT01     | Invalid date   |

| ISO Code | Error  |
|----------|--|
| DT06     | Execution date has been modified in order for transaction to be processed (this code does not lead to a rejection; it is only there for information) |
| DU01     | Message identification is not unique   |
| DU02     | Payment information block is not unique  |
| DU05     | Instruction ID is not unique   |
| FF01     | Invalid file format  |
| MD01     | No mandate   |
| RC01     | Bank identifier incorrect  |
| RR12     | Invalid party identification (Swiss Direct Debit only)   |

*Table 7: Status Reason Codes used in Switzerland*

Financial institutions are also allowed to send individual status information. In that case, the ISO Code "NARR" is sent in the "Code" element and the relevant information entered in the "Additional Information" element.

#### **CH Code**

In addition to the ISO codes, in exceptional cases in Switzerland the status can be shown using specific Swiss or institute-specific codes (in the "Proprietary" element).

## 2.3 Business specifications

The description of the "Payment Status Report" below is based on delivery of a "Customer Credit Transfer Initiation" (pain.001) by the debtor to their financial institution. It follows that the definitions also apply for delivery of a "Customer Direct Debit Initiation" (pain.008) by the creditor to their financial institution.

### 2.3.1 Status overview in the Status Report

#### 2.3.1.1 Answers to incoming messages

A "Customer Credit Transfer Initiation" that is submitted is always answered with at least one "Customer Payment Status Report".

The status report is a direct, instantaneous response by the financial institution to the receipt of a "Customer Credit Transfer Initiation" message. The status report may be a response to the whole message or to certain B-Levels in the message. It is not a processing confirmation by the financial institution.

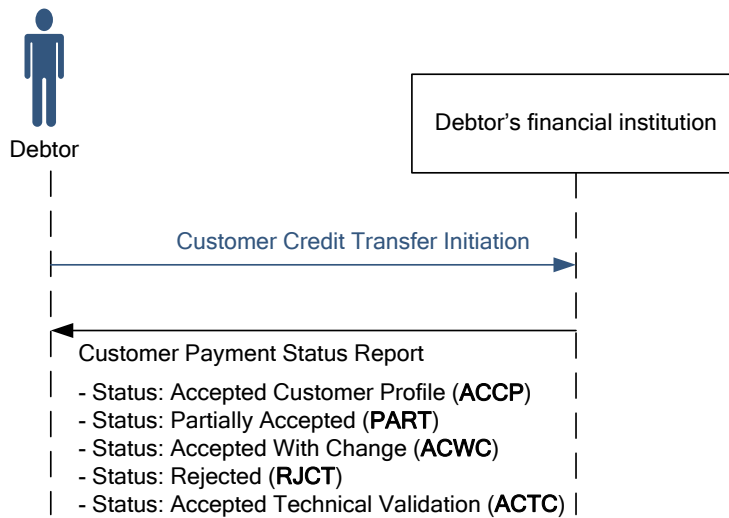

Figure 10: Summary of possible statuses in the Status Report

Generally the status report sends the values ACCP, ACWC, PART and RJCT. Further information status messages giving other values can also be sent (as AOS). Depending on the financial institution and the delivery channel, the "Group Status" may not be sent.

| ☒   | Additional Optional Service | Explanation   |
|-----|-----------------------------|---|
| AOS | Additional status reports   | Other changes in the status of the order, e.g. because of approvals, deletions, execution etc. may be reported back in additional status reports, depending on the financial institution. |

### 2.3.1.2 Status summary

The status is sent back in the "Payment Status Report" in the following elements:

- in the **Group Status <GrpSts>** element, applies to the whole message received "Customer Credit Transfer Initiation" (A-Level)
- in Element **Payment Information Status <PmtInfSts>**, applies to a debit side (a B-Level)
- in Element **Transaction Status <TxSts>**, applies to one transaction (a C-Level).

The following categories of status are generally supported:

| Code                                | Status                      | Description   |
|-------------------------------------|-----------------------------|---|
| ACCP<br>(Accepted Customer Profile) | Group<br>PmtInf             | Checking of syntax and semantics was successful across all A-, B- and C-Levels (incl. Customer Profile [for example authorisation checking at account level])                                   |
| ACWC<br>(Accepted with Change)      | Group<br>PmtInf<br>Transact | Whole message is accepted. Corresponds to today's interpretation of "Warnings" and "Corrections", e.g. correction of value date, concatenated clearing numbers.                                 |
| PART<br>(Partially Accepted)        | Group<br>PmtInf             | One B-Level or more than one B-Level were incorrect (at least 1 correct) or one C-Level or more than one C-Level in one B-Level were incorrect (at least 1 correct)                             |
| RJCT<br>(Rejected)                  | Group<br>PmtInf<br>Transact | If in the "Group Status": whole message is rejected.<br>A-Level is not correct or all B- or C-Levels are incorrect.<br>If "PmtInf": all transactions in the corresponding B-Level are rejected. |

Table 8: Status categories

One other planned status is:

| Code                                    | Status | Description   |
|---|--------|---|
| ACTC<br>(Accepted Technical Validation) | Group  | Checking of syntax and semantics was successful across all A-, B- and C-Levels. |

Table 9: Additional status

| ☒   | Additional Optional Service           | Explanation   |
|-----|---------------------------------------|---|
| AOS | Statuses in "pain.002" status reports | As well as the statuses described above, which are supported by all Swiss financial institutions, other optional statuses are possible at certain institutions. These are: <ul style="list-style-type: none"> <li>• PDNG (Pending)<br/>Status: Group, PmtInf</li> <li>• ACSP (Accepted, Settlement In Process)<br/>Status: Group, PmtInf</li> </ul> |

**Status report with no "Group Status"**

In certain cases the "Group Status" may be omitted.

Example: As an alternative to confirming one "pain.001" message with one "pain.002" message (receipt), certain institutions may also confirm specific B-Levels of a "pain.001" in a "pain.002". These "pain.002" messages do not contain the "Group Status" but always refer to the "Payment Information Status" and the "Transaction Status".

**2.3.1.3 Correct Customer Credit Transfer Initiation message**

Contrary to SEPA recommendations, in Switzerland even positive "Group Status" reports (A-Level status) are sent back.

A correct "Customer Credit Transfer Initiation" message is acknowledged with a "Status Report" including the "Group Status" element ACCP and the A-Level reference that was sent.

**2.3.1.4 Dependencies of Group Status and Payment Information Status**

| Group Status   | Payment Information Status/Transaction Status   |
|----------------|---|
| ACCP/ACTC/ACWC | The whole message was received and is being processed. No details are sent back. There may be warnings/corrections (ACWC) but no errors.  |
| PART/ACWC      | Only part of the message is processed (at least one transaction).<br>Only the incorrect transactions are sent back with "Transaction Status" RJCT. Any changed transactions with "Transaction Status" ACWC are also sent. |
| RJCT           | Whole message is rejected. Errors are sent back.  |

Table 10: Dependencies of Group Status and Payment Information Status



| ☒   | Additional Optional Service                              | Explanation  |
|-----|--|--|
| AOS | Recipient of the Status Report different from the sender | The "Payment Status Report" generally goes to the sender of the "Customer Credit Transfer". That may also be the "Initiation Party". The "pain.002" message can also go to the debtor if they are not the sender of the "pain.001" (e.g. for status reports in the case of a change of status for the order due to approvals, deletions, execution etc.) |

## 2.3.2 Error messages via Status Report

### 2.3.2.1 Types of error

In principle, a distinction can be made between three types of error:

1. **Syntax errors/semantics errors**, i.e. errors in validating the XML schema. These may be triggered by a missing element which is defined as "mandatory", or by the name of an element being written incorrectly. An incorrect sequence of elements, or entering invalid code values for elements for which the values are defined in the XML schema, can also lead to syntax errors.
2. **Technical validation errors** where there are breaches of the Implementation Guidelines. This type of error normally applies to all breaches of those rules in the Guidelines which are not defined in the XML schema. It can also be triggered if, for example, an element is sent for a particular payment type which is defined in the Guidelines as "not permitted" for that payment type.
3. **Business validation errors** during processing. These are problems that occur during processing of the payment, for example if a given IBAN cannot be found or the payment cannot be executed for some other reason.

### 2.3.2.2 Errors due to incorrect schema

Syntax errors identified during schema validation generally result in the whole message being rejected.

**Note:** If a mandatory field was not sent in the original message, or was blank or in breach of a "Pattern", then that element is not sent back in the Payment Status Report. In those cases the error code is either FF01 (schema error) or CH21 (required mandatory field is missing). Normally, the field that was not delivered is mentioned as an error text in the "Additional Information" <AddtlInf> element (e.g. "Mandatory element <IBAN> not sent or blank").

Under certain circumstances, the references can not be read in the message and therefore can not be given back in the Status Report.

### 2.3.2.3 Incorrect Customer Credit Transfer Initiation message

Errors, warnings and corrections in an incoming "Customer Credit Transfer Initiation" are handled as follows:

- Errors, warnings or corrections **at A-Level** (message)
  - No processing of a message with errors at A-Level, including all associated B- and C-Levels (even if they are correct). There is no validation of the corresponding B- and C-Levels.
  - Messages with warnings and corrections at A-Level are processed.
  - The status report contains the "Group Status", the reference from the A-Level with the corresponding error, warning or correction status and its "Reason Code".
- Errors, warnings or corrections **at B-Level** (payment)
  - No processing of a payment group with errors at B-Level, including all the associated C-Levels (even if they are correct). There is no validation of the corresponding C-Levels and also no C-Level references are sent back.
  - Payment groups with warnings and corrections at B-Level are processed.
  - The status report contains the "Group Status"/"Payment Information Status", the references from the A- and B-Level and the corresponding error, warning or correction status and its "Reason Code".
- Errors, warnings or corrections **at C-Level** (transaction)
  - No processing of payments with errors at C-Level.
  - Payments with warnings and corrections at C-Level are processed.
  - The status report contains the "Group Status"/"Payment Information Status"/"Transaction Status", the references from the A-, B- and C-Level, the affected element with the corresponding error, correction or warning and its "Reason Code".

### 2.3.2.4 References in the Payment Status Report

The financial institutions report back all the references in the "pain.001" message in a "pain.002", according to the following chart and rules. B- and C-Levels in "pain.001" are not exactly the same as B- and C-Level in "pain.002", they are one level deeper there.

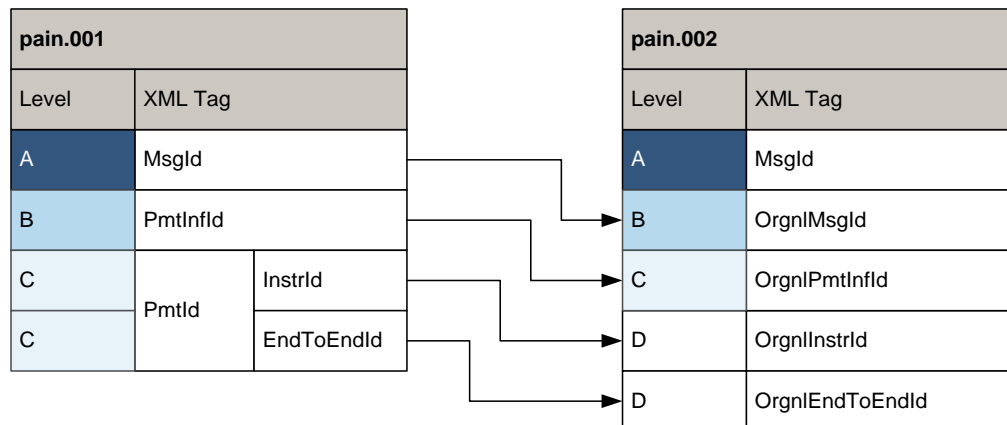

Figure 11: Basic scheme for mapping "pain.001" on to "pain.002"

Depending on the level at which an error occurs while the order is being processed, the corresponding references are returned to the party submitting it. The various versions are described in detail below.

### 2.3.2.5 Degree of detail in the Payment Status Report

Regarding the degree of detail in the "Payment Status Report", the following rules apply:

- All errors from **one** "pain.001" or "pain.008" message are listed in **one** "pain.002" (one "Status Report" per message received, serves as a sort of receipt). In this case the "Group Status" is always sent too.
- If an **A-Level** is rejected, then the references from the A-Level are sent back (without the B- and C-Level, the "Group Status" element contains RJCT). The A-Level reference is what counts.
- If a **B-Level** is rejected, then the references from the A- and B-Levels are sent back (without the C-Level, the "Group Status" element contains PART, the "Payment Information Status" element contains RJCT). The B-Level reference is what counts. If necessary, the client software must add the data from C-Level. If all the B-Levels are incorrect, the "Group Status" is also sent back as RJCT.
- If a **C-Level** is rejected, then the references from the A-, B- and C-Levels are sent back (the "Group Status" element contains PART, the "Payment Information Status" element contains PART, the "Transaction Status" element contains RJCT). What counts is the C-Level reference combined with the B-Level reference. If all the C-Levels in a B-Level are incorrect, the "Payment Information Status" is also sent back as RJCT. If all the C-Levels of all the B-Levels are incorrect, the "Payment Information Status" and the "Group Status" are sent back as RJCT.

Below is an example of a message with, respectively,

- B-Level (PmtInflId\_1) entirely correct
- B-Level (PmtInflId\_2) with errors at B-Level
- B-Level (PmtInflId\_3) with errors at C-Level (InstrId\_8)
- B-Level (PmtInflId\_4) with errors at all C-Levels (InstrId\_10 to InstrId\_12)

In this example all the errors from a "pain.001" message are listed in a "pain.002" (receipt).

| pain.001 und pain.002  |                                     |     | Comments  |  |  |   |               |  |   |             |    |   |           |    |   |           |    |   |           |    |   |                    |     |   |           |    |   |           |    |   |           |    |   |             |    |   |           |    |   |                  |     |   |           |    |   |             |    |   |                   |     |   |                   |     |   |                   |     |   |          |  |   |                      |   |                            |   |               |   |                                     |   |                  |   |                              |   |                  |   |                                 |   |              |   |                              |   |                  |   |                                  |   |              |   |                                  |   |              |   |                                  |   |              |
|--|-------------------------------------|-----|---|--|--|---|---------------|--|---|-------------|----|---|-----------|----|---|-----------|----|---|-----------|----|---|--------------------|-----|---|-----------|----|---|-----------|----|---|-----------|----|---|-------------|----|---|-----------|----|---|------------------|-----|---|-----------|----|---|-------------|----|---|-------------------|-----|---|-------------------|-----|---|-------------------|-----|---|----------|--|---|----------------------|---|----------------------------|---|---------------|---|-------------------------------------|---|------------------|---|------------------------------|---|------------------|---|---------------------------------|---|--------------|---|------------------------------|---|------------------|---|----------------------------------|---|--------------|---|----------------------------------|---|--------------|---|----------------------------------|---|--------------|
| <table border="1"> <thead> <tr> <th colspan="3">pain.001</th> </tr> </thead> <tbody> <tr> <td>A</td> <td>Cstmr-Msgld_1</td> <td></td> </tr> <tr> <td>B</td> <td>PmtInflId_1</td> <td>OK</td> </tr> <tr> <td>C</td> <td>InstrId_1</td> <td>OK</td> </tr> <tr> <td>C</td> <td>InstrId_2</td> <td>OK</td> </tr> <tr> <td>C</td> <td>InstrId_3</td> <td>OK</td> </tr> <tr> <td>B</td> <td><i>PmtInflId_2</i></td> <td>NOK</td> </tr> <tr> <td>C</td> <td>InstrId_4</td> <td>OK</td> </tr> <tr> <td>C</td> <td>InstrId_5</td> <td>OK</td> </tr> <tr> <td>C</td> <td>InstrId_6</td> <td>OK</td> </tr> <tr> <td>B</td> <td>PmtInflId_3</td> <td>OK</td> </tr> <tr> <td>C</td> <td>InstrId_7</td> <td>OK</td> </tr> <tr> <td>C</td> <td><i>InstrId_8</i></td> <td>NOK</td> </tr> <tr> <td>C</td> <td>InstrId_9</td> <td>OK</td> </tr> <tr> <td>B</td> <td>PmtInflId_4</td> <td>OK</td> </tr> <tr> <td>C</td> <td><i>InstrId_10</i></td> <td>NOK</td> </tr> <tr> <td>C</td> <td><i>InstrId_11</i></td> <td>NOK</td> </tr> <tr> <td>C</td> <td><i>InstrId_12</i></td> <td>NOK</td> </tr> </tbody> </table> |                                     |     | pain.001  |  |  | A | Cstmr-Msgld_1 |  | B | PmtInflId_1 | OK | C | InstrId_1 | OK | C | InstrId_2 | OK | C | InstrId_3 | OK | B | <i>PmtInflId_2</i> | NOK | C | InstrId_4 | OK | C | InstrId_5 | OK | C | InstrId_6 | OK | B | PmtInflId_3 | OK | C | InstrId_7 | OK | C | <i>InstrId_8</i> | NOK | C | InstrId_9 | OK | B | PmtInflId_4 | OK | C | <i>InstrId_10</i> | NOK | C | <i>InstrId_11</i> | NOK | C | <i>InstrId_12</i> | NOK | <table border="1"> <thead> <tr> <th colspan="2">pain.002</th> </tr> </thead> <tbody> <tr> <td>A</td> <td>Msgld = Agnt-Msgld_1</td> </tr> <tr> <td>B</td> <td>OrgnlMsgld = Cstmr-Msgld_1</td> </tr> <tr> <td>B</td> <td>GrpSts = PART</td> </tr> <tr> <td>C</td> <td>OrgnlPmtInflId = <i>PmtInflId_2</i></td> </tr> <tr> <td>C</td> <td>PmtInfSts = RJCT</td> </tr> <tr> <td>C</td> <td>OrgnlPmtInflId = PmtInflId_3</td> </tr> <tr> <td>C</td> <td>PmtInfSts = PART</td> </tr> <tr> <td>D</td> <td>OrgnlInstrId = <i>InstrId_8</i></td> </tr> <tr> <td>D</td> <td>TxSts = RJCT</td> </tr> <tr> <td>C</td> <td>OrgnlPmtInflId = PmtInflId_4</td> </tr> <tr> <td>C</td> <td>PmtInfSts = RJCT</td> </tr> <tr> <td>D</td> <td>OrgnlInstrId = <i>InstrId_10</i></td> </tr> <tr> <td>D</td> <td>TxSts = RJCT</td> </tr> <tr> <td>D</td> <td>OrgnlInstrId = <i>InstrId_11</i></td> </tr> <tr> <td>D</td> <td>TxSts = RJCT</td> </tr> <tr> <td>D</td> <td>OrgnlInstrId = <i>InstrId_12</i></td> </tr> <tr> <td>D</td> <td>TxSts = RJCT</td> </tr> </tbody> </table> | pain.002 |  | A | Msgld = Agnt-Msgld_1 | B | OrgnlMsgld = Cstmr-Msgld_1 | B | GrpSts = PART | C | OrgnlPmtInflId = <i>PmtInflId_2</i> | C | PmtInfSts = RJCT | C | OrgnlPmtInflId = PmtInflId_3 | C | PmtInfSts = PART | D | OrgnlInstrId = <i>InstrId_8</i> | D | TxSts = RJCT | C | OrgnlPmtInflId = PmtInflId_4 | C | PmtInfSts = RJCT | D | OrgnlInstrId = <i>InstrId_10</i> | D | TxSts = RJCT | D | OrgnlInstrId = <i>InstrId_11</i> | D | TxSts = RJCT | D | OrgnlInstrId = <i>InstrId_12</i> | D | TxSts = RJCT |
| pain.001   |                                     |     |   |  |  |   |               |  |   |             |    |   |           |    |   |           |    |   |           |    |   |                    |     |   |           |    |   |           |    |   |           |    |   |             |    |   |           |    |   |                  |     |   |           |    |   |             |    |   |                   |     |   |                   |     |   |                   |     |   |          |  |   |                      |   |                            |   |               |   |                                     |   |                  |   |                              |   |                  |   |                                 |   |              |   |                              |   |                  |   |                                  |   |              |   |                                  |   |              |   |                                  |   |              |
| A  | Cstmr-Msgld_1                       |     |   |  |  |   |               |  |   |             |    |   |           |    |   |           |    |   |           |    |   |                    |     |   |           |    |   |           |    |   |           |    |   |             |    |   |           |    |   |                  |     |   |           |    |   |             |    |   |                   |     |   |                   |     |   |                   |     |   |          |  |   |                      |   |                            |   |               |   |                                     |   |                  |   |                              |   |                  |   |                                 |   |              |   |                              |   |                  |   |                                  |   |              |   |                                  |   |              |   |                                  |   |              |
| B  | PmtInflId_1                         | OK  |   |  |  |   |               |  |   |             |    |   |           |    |   |           |    |   |           |    |   |                    |     |   |           |    |   |           |    |   |           |    |   |             |    |   |           |    |   |                  |     |   |           |    |   |             |    |   |                   |     |   |                   |     |   |                   |     |   |          |  |   |                      |   |                            |   |               |   |                                     |   |                  |   |                              |   |                  |   |                                 |   |              |   |                              |   |                  |   |                                  |   |              |   |                                  |   |              |   |                                  |   |              |
| C  | InstrId_1                           | OK  |   |  |  |   |               |  |   |             |    |   |           |    |   |           |    |   |           |    |   |                    |     |   |           |    |   |           |    |   |           |    |   |             |    |   |           |    |   |                  |     |   |           |    |   |             |    |   |                   |     |   |                   |     |   |                   |     |   |          |  |   |                      |   |                            |   |               |   |                                     |   |                  |   |                              |   |                  |   |                                 |   |              |   |                              |   |                  |   |                                  |   |              |   |                                  |   |              |   |                                  |   |              |
| C  | InstrId_2                           | OK  |   |  |  |   |               |  |   |             |    |   |           |    |   |           |    |   |           |    |   |                    |     |   |           |    |   |           |    |   |           |    |   |             |    |   |           |    |   |                  |     |   |           |    |   |             |    |   |                   |     |   |                   |     |   |                   |     |   |          |  |   |                      |   |                            |   |               |   |                                     |   |                  |   |                              |   |                  |   |                                 |   |              |   |                              |   |                  |   |                                  |   |              |   |                                  |   |              |   |                                  |   |              |
| C  | InstrId_3                           | OK  |   |  |  |   |               |  |   |             |    |   |           |    |   |           |    |   |           |    |   |                    |     |   |           |    |   |           |    |   |           |    |   |             |    |   |           |    |   |                  |     |   |           |    |   |             |    |   |                   |     |   |                   |     |   |                   |     |   |          |  |   |                      |   |                            |   |               |   |                                     |   |                  |   |                              |   |                  |   |                                 |   |              |   |                              |   |                  |   |                                  |   |              |   |                                  |   |              |   |                                  |   |              |
| B  | <i>PmtInflId_2</i>                  | NOK |   |  |  |   |               |  |   |             |    |   |           |    |   |           |    |   |           |    |   |                    |     |   |           |    |   |           |    |   |           |    |   |             |    |   |           |    |   |                  |     |   |           |    |   |             |    |   |                   |     |   |                   |     |   |                   |     |   |          |  |   |                      |   |                            |   |               |   |                                     |   |                  |   |                              |   |                  |   |                                 |   |              |   |                              |   |                  |   |                                  |   |              |   |                                  |   |              |   |                                  |   |              |
| C  | InstrId_4                           | OK  |   |  |  |   |               |  |   |             |    |   |           |    |   |           |    |   |           |    |   |                    |     |   |           |    |   |           |    |   |           |    |   |             |    |   |           |    |   |                  |     |   |           |    |   |             |    |   |                   |     |   |                   |     |   |                   |     |   |          |  |   |                      |   |                            |   |               |   |                                     |   |                  |   |                              |   |                  |   |                                 |   |              |   |                              |   |                  |   |                                  |   |              |   |                                  |   |              |   |                                  |   |              |
| C  | InstrId_5                           | OK  |   |  |  |   |               |  |   |             |    |   |           |    |   |           |    |   |           |    |   |                    |     |   |           |    |   |           |    |   |           |    |   |             |    |   |           |    |   |                  |     |   |           |    |   |             |    |   |                   |     |   |                   |     |   |                   |     |   |          |  |   |                      |   |                            |   |               |   |                                     |   |                  |   |                              |   |                  |   |                                 |   |              |   |                              |   |                  |   |                                  |   |              |   |                                  |   |              |   |                                  |   |              |
| C  | InstrId_6                           | OK  |   |  |  |   |               |  |   |             |    |   |           |    |   |           |    |   |           |    |   |                    |     |   |           |    |   |           |    |   |           |    |   |             |    |   |           |    |   |                  |     |   |           |    |   |             |    |   |                   |     |   |                   |     |   |                   |     |   |          |  |   |                      |   |                            |   |               |   |                                     |   |                  |   |                              |   |                  |   |                                 |   |              |   |                              |   |                  |   |                                  |   |              |   |                                  |   |              |   |                                  |   |              |
| B  | PmtInflId_3                         | OK  |   |  |  |   |               |  |   |             |    |   |           |    |   |           |    |   |           |    |   |                    |     |   |           |    |   |           |    |   |           |    |   |             |    |   |           |    |   |                  |     |   |           |    |   |             |    |   |                   |     |   |                   |     |   |                   |     |   |          |  |   |                      |   |                            |   |               |   |                                     |   |                  |   |                              |   |                  |   |                                 |   |              |   |                              |   |                  |   |                                  |   |              |   |                                  |   |              |   |                                  |   |              |
| C  | InstrId_7                           | OK  |   |  |  |   |               |  |   |             |    |   |           |    |   |           |    |   |           |    |   |                    |     |   |           |    |   |           |    |   |           |    |   |             |    |   |           |    |   |                  |     |   |           |    |   |             |    |   |                   |     |   |                   |     |   |                   |     |   |          |  |   |                      |   |                            |   |               |   |                                     |   |                  |   |                              |   |                  |   |                                 |   |              |   |                              |   |                  |   |                                  |   |              |   |                                  |   |              |   |                                  |   |              |
| C  | <i>InstrId_8</i>                    | NOK |   |  |  |   |               |  |   |             |    |   |           |    |   |           |    |   |           |    |   |                    |     |   |           |    |   |           |    |   |           |    |   |             |    |   |           |    |   |                  |     |   |           |    |   |             |    |   |                   |     |   |                   |     |   |                   |     |   |          |  |   |                      |   |                            |   |               |   |                                     |   |                  |   |                              |   |                  |   |                                 |   |              |   |                              |   |                  |   |                                  |   |              |   |                                  |   |              |   |                                  |   |              |
| C  | InstrId_9                           | OK  |   |  |  |   |               |  |   |             |    |   |           |    |   |           |    |   |           |    |   |                    |     |   |           |    |   |           |    |   |           |    |   |             |    |   |           |    |   |                  |     |   |           |    |   |             |    |   |                   |     |   |                   |     |   |                   |     |   |          |  |   |                      |   |                            |   |               |   |                                     |   |                  |   |                              |   |                  |   |                                 |   |              |   |                              |   |                  |   |                                  |   |              |   |                                  |   |              |   |                                  |   |              |
| B  | PmtInflId_4                         | OK  |   |  |  |   |               |  |   |             |    |   |           |    |   |           |    |   |           |    |   |                    |     |   |           |    |   |           |    |   |           |    |   |             |    |   |           |    |   |                  |     |   |           |    |   |             |    |   |                   |     |   |                   |     |   |                   |     |   |          |  |   |                      |   |                            |   |               |   |                                     |   |                  |   |                              |   |                  |   |                                 |   |              |   |                              |   |                  |   |                                  |   |              |   |                                  |   |              |   |                                  |   |              |
| C  | <i>InstrId_10</i>                   | NOK |   |  |  |   |               |  |   |             |    |   |           |    |   |           |    |   |           |    |   |                    |     |   |           |    |   |           |    |   |           |    |   |             |    |   |           |    |   |                  |     |   |           |    |   |             |    |   |                   |     |   |                   |     |   |                   |     |   |          |  |   |                      |   |                            |   |               |   |                                     |   |                  |   |                              |   |                  |   |                                 |   |              |   |                              |   |                  |   |                                  |   |              |   |                                  |   |              |   |                                  |   |              |
| C  | <i>InstrId_11</i>                   | NOK |   |  |  |   |               |  |   |             |    |   |           |    |   |           |    |   |           |    |   |                    |     |   |           |    |   |           |    |   |           |    |   |             |    |   |           |    |   |                  |     |   |           |    |   |             |    |   |                   |     |   |                   |     |   |                   |     |   |          |  |   |                      |   |                            |   |               |   |                                     |   |                  |   |                              |   |                  |   |                                 |   |              |   |                              |   |                  |   |                                  |   |              |   |                                  |   |              |   |                                  |   |              |
| C  | <i>InstrId_12</i>                   | NOK |   |  |  |   |               |  |   |             |    |   |           |    |   |           |    |   |           |    |   |                    |     |   |           |    |   |           |    |   |           |    |   |             |    |   |           |    |   |                  |     |   |           |    |   |             |    |   |                   |     |   |                   |     |   |                   |     |   |          |  |   |                      |   |                            |   |               |   |                                     |   |                  |   |                              |   |                  |   |                                 |   |              |   |                              |   |                  |   |                                  |   |              |   |                                  |   |              |   |                                  |   |              |
| pain.002   |                                     |     |   |  |  |   |               |  |   |             |    |   |           |    |   |           |    |   |           |    |   |                    |     |   |           |    |   |           |    |   |           |    |   |             |    |   |           |    |   |                  |     |   |           |    |   |             |    |   |                   |     |   |                   |     |   |                   |     |   |          |  |   |                      |   |                            |   |               |   |                                     |   |                  |   |                              |   |                  |   |                                 |   |              |   |                              |   |                  |   |                                  |   |              |   |                                  |   |              |   |                                  |   |              |
| A  | Msgld = Agnt-Msgld_1                |     |   |  |  |   |               |  |   |             |    |   |           |    |   |           |    |   |           |    |   |                    |     |   |           |    |   |           |    |   |           |    |   |             |    |   |           |    |   |                  |     |   |           |    |   |             |    |   |                   |     |   |                   |     |   |                   |     |   |          |  |   |                      |   |                            |   |               |   |                                     |   |                  |   |                              |   |                  |   |                                 |   |              |   |                              |   |                  |   |                                  |   |              |   |                                  |   |              |   |                                  |   |              |
| B  | OrgnlMsgld = Cstmr-Msgld_1          |     |   |  |  |   |               |  |   |             |    |   |           |    |   |           |    |   |           |    |   |                    |     |   |           |    |   |           |    |   |           |    |   |             |    |   |           |    |   |                  |     |   |           |    |   |             |    |   |                   |     |   |                   |     |   |                   |     |   |          |  |   |                      |   |                            |   |               |   |                                     |   |                  |   |                              |   |                  |   |                                 |   |              |   |                              |   |                  |   |                                  |   |              |   |                                  |   |              |   |                                  |   |              |
| B  | GrpSts = PART                       |     |   |  |  |   |               |  |   |             |    |   |           |    |   |           |    |   |           |    |   |                    |     |   |           |    |   |           |    |   |           |    |   |             |    |   |           |    |   |                  |     |   |           |    |   |             |    |   |                   |     |   |                   |     |   |                   |     |   |          |  |   |                      |   |                            |   |               |   |                                     |   |                  |   |                              |   |                  |   |                                 |   |              |   |                              |   |                  |   |                                  |   |              |   |                                  |   |              |   |                                  |   |              |
| C  | OrgnlPmtInflId = <i>PmtInflId_2</i> |     |   |  |  |   |               |  |   |             |    |   |           |    |   |           |    |   |           |    |   |                    |     |   |           |    |   |           |    |   |           |    |   |             |    |   |           |    |   |                  |     |   |           |    |   |             |    |   |                   |     |   |                   |     |   |                   |     |   |          |  |   |                      |   |                            |   |               |   |                                     |   |                  |   |                              |   |                  |   |                                 |   |              |   |                              |   |                  |   |                                  |   |              |   |                                  |   |              |   |                                  |   |              |
| C  | PmtInfSts = RJCT                    |     |   |  |  |   |               |  |   |             |    |   |           |    |   |           |    |   |           |    |   |                    |     |   |           |    |   |           |    |   |           |    |   |             |    |   |           |    |   |                  |     |   |           |    |   |             |    |   |                   |     |   |                   |     |   |                   |     |   |          |  |   |                      |   |                            |   |               |   |                                     |   |                  |   |                              |   |                  |   |                                 |   |              |   |                              |   |                  |   |                                  |   |              |   |                                  |   |              |   |                                  |   |              |
| C  | OrgnlPmtInflId = PmtInflId_3        |     |   |  |  |   |               |  |   |             |    |   |           |    |   |           |    |   |           |    |   |                    |     |   |           |    |   |           |    |   |           |    |   |             |    |   |           |    |   |                  |     |   |           |    |   |             |    |   |                   |     |   |                   |     |   |                   |     |   |          |  |   |                      |   |                            |   |               |   |                                     |   |                  |   |                              |   |                  |   |                                 |   |              |   |                              |   |                  |   |                                  |   |              |   |                                  |   |              |   |                                  |   |              |
| C  | PmtInfSts = PART                    |     |   |  |  |   |               |  |   |             |    |   |           |    |   |           |    |   |           |    |   |                    |     |   |           |    |   |           |    |   |           |    |   |             |    |   |           |    |   |                  |     |   |           |    |   |             |    |   |                   |     |   |                   |     |   |                   |     |   |          |  |   |                      |   |                            |   |               |   |                                     |   |                  |   |                              |   |                  |   |                                 |   |              |   |                              |   |                  |   |                                  |   |              |   |                                  |   |              |   |                                  |   |              |
| D  | OrgnlInstrId = <i>InstrId_8</i>     |     |   |  |  |   |               |  |   |             |    |   |           |    |   |           |    |   |           |    |   |                    |     |   |           |    |   |           |    |   |           |    |   |             |    |   |           |    |   |                  |     |   |           |    |   |             |    |   |                   |     |   |                   |     |   |                   |     |   |          |  |   |                      |   |                            |   |               |   |                                     |   |                  |   |                              |   |                  |   |                                 |   |              |   |                              |   |                  |   |                                  |   |              |   |                                  |   |              |   |                                  |   |              |
| D  | TxSts = RJCT                        |     |   |  |  |   |               |  |   |             |    |   |           |    |   |           |    |   |           |    |   |                    |     |   |           |    |   |           |    |   |           |    |   |             |    |   |           |    |   |                  |     |   |           |    |   |             |    |   |                   |     |   |                   |     |   |                   |     |   |          |  |   |                      |   |                            |   |               |   |                                     |   |                  |   |                              |   |                  |   |                                 |   |              |   |                              |   |                  |   |                                  |   |              |   |                                  |   |              |   |                                  |   |              |
| C  | OrgnlPmtInflId = PmtInflId_4        |     |   |  |  |   |               |  |   |             |    |   |           |    |   |           |    |   |           |    |   |                    |     |   |           |    |   |           |    |   |           |    |   |             |    |   |           |    |   |                  |     |   |           |    |   |             |    |   |                   |     |   |                   |     |   |                   |     |   |          |  |   |                      |   |                            |   |               |   |                                     |   |                  |   |                              |   |                  |   |                                 |   |              |   |                              |   |                  |   |                                  |   |              |   |                                  |   |              |   |                                  |   |              |
| C  | PmtInfSts = RJCT                    |     |   |  |  |   |               |  |   |             |    |   |           |    |   |           |    |   |           |    |   |                    |     |   |           |    |   |           |    |   |           |    |   |             |    |   |           |    |   |                  |     |   |           |    |   |             |    |   |                   |     |   |                   |     |   |                   |     |   |          |  |   |                      |   |                            |   |               |   |                                     |   |                  |   |                              |   |                  |   |                                 |   |              |   |                              |   |                  |   |                                  |   |              |   |                                  |   |              |   |                                  |   |              |
| D  | OrgnlInstrId = <i>InstrId_10</i>    |     |   |  |  |   |               |  |   |             |    |   |           |    |   |           |    |   |           |    |   |                    |     |   |           |    |   |           |    |   |           |    |   |             |    |   |           |    |   |                  |     |   |           |    |   |             |    |   |                   |     |   |                   |     |   |                   |     |   |          |  |   |                      |   |                            |   |               |   |                                     |   |                  |   |                              |   |                  |   |                                 |   |              |   |                              |   |                  |   |                                  |   |              |   |                                  |   |              |   |                                  |   |              |
| D  | TxSts = RJCT                        |     |   |  |  |   |               |  |   |             |    |   |           |    |   |           |    |   |           |    |   |                    |     |   |           |    |   |           |    |   |           |    |   |             |    |   |           |    |   |                  |     |   |           |    |   |             |    |   |                   |     |   |                   |     |   |                   |     |   |          |  |   |                      |   |                            |   |               |   |                                     |   |                  |   |                              |   |                  |   |                                 |   |              |   |                              |   |                  |   |                                  |   |              |   |                                  |   |              |   |                                  |   |              |
| D  | OrgnlInstrId = <i>InstrId_11</i>    |     |   |  |  |   |               |  |   |             |    |   |           |    |   |           |    |   |           |    |   |                    |     |   |           |    |   |           |    |   |           |    |   |             |    |   |           |    |   |                  |     |   |           |    |   |             |    |   |                   |     |   |                   |     |   |                   |     |   |          |  |   |                      |   |                            |   |               |   |                                     |   |                  |   |                              |   |                  |   |                                 |   |              |   |                              |   |                  |   |                                  |   |              |   |                                  |   |              |   |                                  |   |              |
| D  | TxSts = RJCT                        |     |   |  |  |   |               |  |   |             |    |   |           |    |   |           |    |   |           |    |   |                    |     |   |           |    |   |           |    |   |           |    |   |             |    |   |           |    |   |                  |     |   |           |    |   |             |    |   |                   |     |   |                   |     |   |                   |     |   |          |  |   |                      |   |                            |   |               |   |                                     |   |                  |   |                              |   |                  |   |                                 |   |              |   |                              |   |                  |   |                                  |   |              |   |                                  |   |              |   |                                  |   |              |
| D  | OrgnlInstrId = <i>InstrId_12</i>    |     |   |  |  |   |               |  |   |             |    |   |           |    |   |           |    |   |           |    |   |                    |     |   |           |    |   |           |    |   |           |    |   |             |    |   |           |    |   |                  |     |   |           |    |   |             |    |   |                   |     |   |                   |     |   |                   |     |   |          |  |   |                      |   |                            |   |               |   |                                     |   |                  |   |                              |   |                  |   |                                 |   |              |   |                              |   |                  |   |                                  |   |              |   |                                  |   |              |   |                                  |   |              |
| D  | TxSts = RJCT                        |     |   |  |  |   |               |  |   |             |    |   |           |    |   |           |    |   |           |    |   |                    |     |   |           |    |   |           |    |   |           |    |   |             |    |   |           |    |   |                  |     |   |           |    |   |             |    |   |                   |     |   |                   |     |   |                   |     |   |          |  |   |                      |   |                            |   |               |   |                                     |   |                  |   |                              |   |                  |   |                                 |   |              |   |                              |   |                  |   |                                  |   |              |   |                                  |   |              |   |                                  |   |              |
|  |                                     |     | <p>Msgld_1: The status for the whole message (Group) is PART.</p> <p>PmtInflId_1: No notification for correct B- and C-Levels.</p> <p>PmtInflId_2: The status for the B-Level is RJCT. For incorrect B-Levels, the reference from the incorrect B-Level is sent.</p> <p>PmtInflId_3: The status of the B-Level is implicitly PART. For incorrect C-Level, the reference for B- and C-Level is sent.</p> <p>PmtInflId_4: The status of the B-Level is implicitly RJCT. The reference for the B-Level and the references for all the incorrect C-Levels are sent.</p> |  |  |   |               |  |   |             |    |   |           |    |   |           |    |   |           |    |   |                    |     |   |           |    |   |           |    |   |           |    |   |             |    |   |           |    |   |                  |     |   |           |    |   |             |    |   |                   |     |   |                   |     |   |                   |     |   |          |  |   |                      |   |                            |   |               |   |                                     |   |                  |   |                              |   |                  |   |                                 |   |              |   |                              |   |                  |   |                                  |   |              |   |                                  |   |              |   |                                  |   |              |

Table 11: Example of the degree of detail in a status report

2.3.2.6 **pain.001 errors – pain.002 references and statuses**

**pain.001 errors at A-Level**

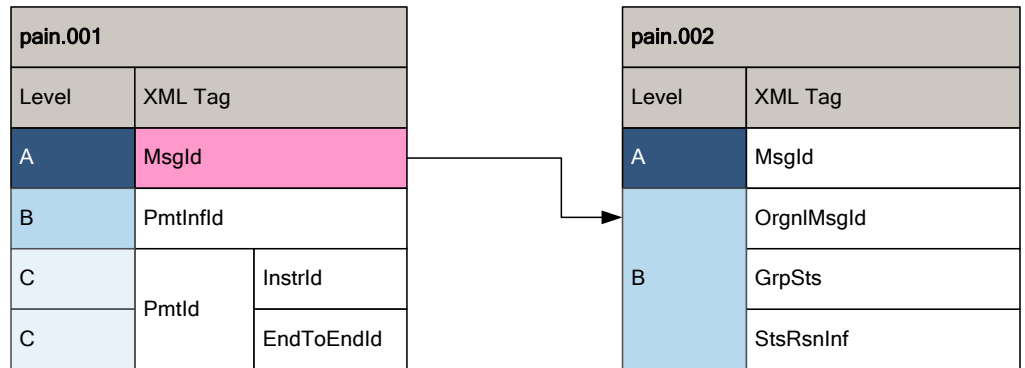

Figure 12: Errors at "pain.001" A-Level – References in "pain.002"

**pain.001 errors at B-Level**

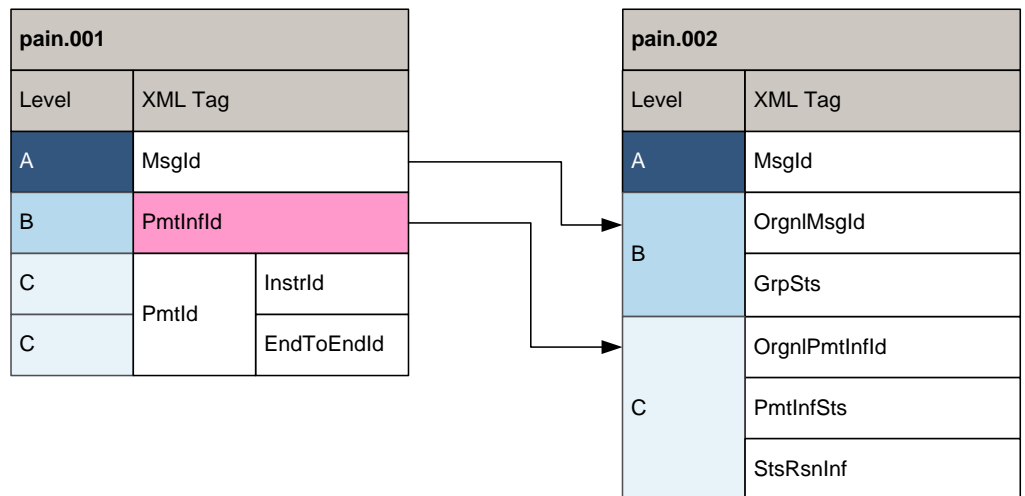

Figure 13: Errors at "pain.001" B-Level – References in "pain.002"

**pain.001 errors at C-Level**

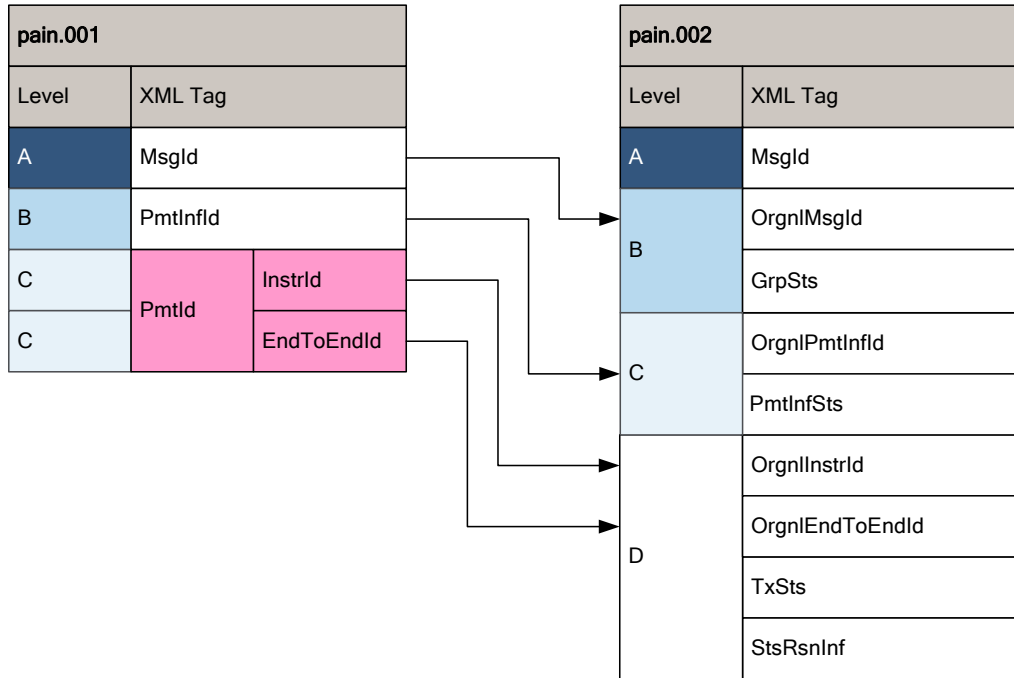

Figure 14: Errors at "pain.001" C-Level – References in "pain.002"

**Comment:** If no Instruction Identification <InstrId> is sent at C-Level in the "pain.001", contrary to the recommendations of the Swiss banks, then in the "pain.002" in the event of an error the corresponding field is given the status "NOTPROVIDED". A correct transaction is executed even if the "Instruction Identification" (<InstrId>) element at C-Level is not sent. Since <InstrId> is already defined as mandatory for "pain.008" in the Swiss schema, the lack of this element in a "pain.008" message triggers a syntax error.

**Comments:**

- Where there are syntax errors (breakdown of the XML schema), then depending on the value not all the details may be sent back. (If no status report can be generated because of a fatal error, then the sender is generally contacted by the financial institution via other channels.)
- In addition to the references, wherever possible the incorrect original element is also sent back in the Status Report (see the examples in the Appendix).
- For additional elements and extended scope of Status Reports see also section 2.3.2.3.

**Summary matrix for errors in pain.001 in relation to statuses in pain.002**

The following matrix shows all the combinations again in summary form:

|  |               | pain.002    |             |                            |         |             |          |
|--|---------------|-------------|-------------|----------------------------|---------|-------------|----------|
| pain.001   | Statuses      |             |             | Original IDs from pain.001 |         |             |          |
| Error at   | Group         | Payment Inf | Transaction | Message                    | Payment | Instruction | EndToEnd |
| A-Level  | RJCT          |             |             | X                          |         |             |          |
| B-Level (all)  | RJCT          | RJCT        |             | X                          | X       |             |          |
| B-Level (some)   | PART          | RJCT        |             | X                          | X       |             |          |
| C-Level (all)  | RJCT          | RJCT        | RJCT        | X                          | X       | X           | X        |
| C-Level (all of one B-Level, at least 1 B-Level is good) | PART          | RJCT        | RJCT        | X                          | X       | X           | X        |
| C-Level (some of one B-Level)                            | PART          | PART        | RJCT        | X                          | X       | X           | X        |
| Warnings at  |               |             |             |                            |         |             |          |
| Warnings at  | Group         | Payment Inf | Transaction | Message                    | Payment | Instruction | EndToEnd |
| A-Level  | ACWC          |             |             | X                          |         |             |          |
| B-Level (some or all)                                    | ACCP          | ACWC        |             | X                          | X       |             |          |
| C-Level (some or all)                                    | ACCP          | ACWC        | ACWC        | X                          | X       | X           | X        |
| No errors  |               |             |             |                            |         |             |          |
| No errors  | Group         | Payment Inf | Transaction | Message                    | Payment | Instruction | EndToEnd |
| A-Level  | ACCP/<br>ACTC |             |             | X                          |         |             |          |

Table 12: Summary matrix for errors in "pain.001" in relation to statuses in "pain.002"

**2.3.2.7 pain.001 errors – possible Group Statuses**

**pain.001 errors at A-Level**

| Status          |               | Possible reasons  |
|-----------------|---------------|---|
| <b>pain.002</b> |               | There was an error in the Group Header (elements 1.0 to 1.9) e.g.: <ul style="list-style-type: none"> <li>• Creation Date Time invalid</li> <li>• Number Of Transactions incorrect</li> <li>• Control Sum incorrect</li> <li>• Initiating Party invalid</li> <li>• Forwarding Agent invalid</li> <li>• ...</li> </ul> |
| Level           | XML Tag       |   |
| A               | Msgld         |   |
| B               | OrgnlMsgld    |   |
| B               | GrpSts = RJCT |   |

Table 13: Group Status

Where there are errors in "pain.001" at A-Level, no "Payment Information Statuses" or "Transaction Statuses" are sent back.

**pain.001 errors at B-Level**

| Group Status    |                     | Possible reasons   |
|-----------------|---------------------|--|
| <b>pain.002</b> |                     | All C-Levels for all B-Levels are incorrect. For possible errors at B-Level see next section (Group Status = RJCT).  |
| Level           | XML Tag             |  |
| A               | Msgld               |  |
| B               | OrgnlMsgld          |  |
| B               | GrpSts = RJCT       |  |
| <b>pain.002</b> |                     | There is an error in the "Payment Information" (elements 2.0 to 2.26) <ul style="list-style-type: none"> <li>• Invalid Payment Method</li> <li>• Invalid Payment Type Information</li> <li>• Debtor Account is not permitted</li> <li>• Implicit status, if all C-Levels of this B-Level are incorrect</li> <li>• ...</li> </ul> |
| Level           | XML Tag             |  |
| A               | Msgld               |  |
| B               | OrgnlMsgld          |  |
| B               | Group Status = PART |  |
| C               | PmtInfSts = RJCT    |  |

Table 14: Payment Information Status



**pain.001 errors at C-Level**

| Group Status    |                  | Possible reasons   |
|-----------------|------------------|--|
| <b>pain.002</b> |                  | Implicit status if all C-Levels of a message are incorrect. Errors at C-Level could be, for example: <ul style="list-style-type: none"> <li>• Payment Identification missing</li> <li>• Clearing Channel not permitted</li> <li>• Contradictions such as Service Level Code = SEPA with Currency Of Transfer = USD</li> <li>• Ultimate Debtor does not exist</li> <li>• ...</li> </ul> |
| Level           | XML Tag          |  |
| A               | MsgId            |  |
| B               | OrgnlMsgId       |  |
| B               | GrpSts = RJCT    |  |
| C               | OrgnlPmtInfId    |  |
| C               | PmtInfSts = RJCT |  |
| D               | OrgnlInstrId     |  |
| D               | TxSts = RJCT     |  |

Table 15: Transaction Status

**2.3.2.8 Status Reason Information**

For every negative "Transaction Status", the corresponding "Status Reason Information" is sent back. The information is defined as a complex type and consists of the following main elements:

1. **Originator** <Orgtr>  
 Swiss financial institutions enter the sender BIC here (e.g. UBSWCHZH). In exceptional cases the sender's name can be given, if the creator of the Status Information is not the same as the message sender ("Group Header/Initiating Party" or "Group Header/Creditor Agent").

2. **Reason Code** <Rsn>/<Cd>  
 These may be either ISO-registered codes or the codes that are possible for Swiss financial institutions (these are sent in the Proprietary <Rsn>/<Prtry> element).

A list of possible codes can be found in the Implementation Guidelines and as an external code list on [www.iso20022.org](http://www.iso20022.org).

3. **Additional Information** <AddtlInf>  
 (105 characters for error text)  
 Can be used optionally to send additional information about the "Reason Code".

### 3 Examples

This section shows examples of status reports as "pain.002" messages responding to a "pain.001" payment message (Customer Credit Transfer Initiation) that has been received.

For the details of the examples in XML, the following assumptions were made:

**First example: OK case**

The first example shows a positive response message (Customer Payment Status Report pain.002) to a payment message that has been received (Customer Credit Transfer Initiation pain.001).

**Second example: NOK case**

The second example shows a negative response message (Customer Payment Status Report pain.002) to a collection order that has been received. Here the following assumption was made: in the payment message that was received (Customer Credit Transfer Initiation pain.001), one of the transactions includes an invalid IBAN for the creditor (example: QQ61 1904 3002 3456 7320).

Data for the NOK case:

| Field designation                                    | Content                  |
|--|--------------------------|
| Identification of the original message               | MSG-01                   |
| Identification of the original group                 | PMTINF-02                |
| Identification of the original transaction           | INSTR-02-02              |
| Original end-to-end identification                   | ENDTOENDID-003           |
| Error code (Group Status)                            | PART                     |
| Error code (Payment Information Status)              | PART                     |
| Error code (Transaction Status)                      | RJCT                     |
| Error code (Reason)                                  | CH16                     |
| Contents of the incorrect element (Creditor Account) | QQ61 1904 3002 3456 7320 |

For XML versions of the examples see Appendix A.

## Appendix A: XML schema and examples

---

### XML-Schema

The original XML schema

- ***pain.002.001.03.ch.02.xsd***

is published on the [www.iso-payments.ch](http://www.iso-payments.ch) website.

It should preferably be opened using specific XML software.

### Examples

On the [www.iso-payments.ch](http://www.iso-payments.ch) website, the examples described in this document are published as XML files:

- ***pain\_002\_CT\_Beispiel\_OK.xml*** (First example from section 3)
- ***pain\_002\_CT\_Beispiel\_NOK.xml*** (Second example from section 3)

## Appendix B: Examples Status Reports

### Example 1: Accepted

- pain.001: correct syntax
- pain.002: positive status message at message level

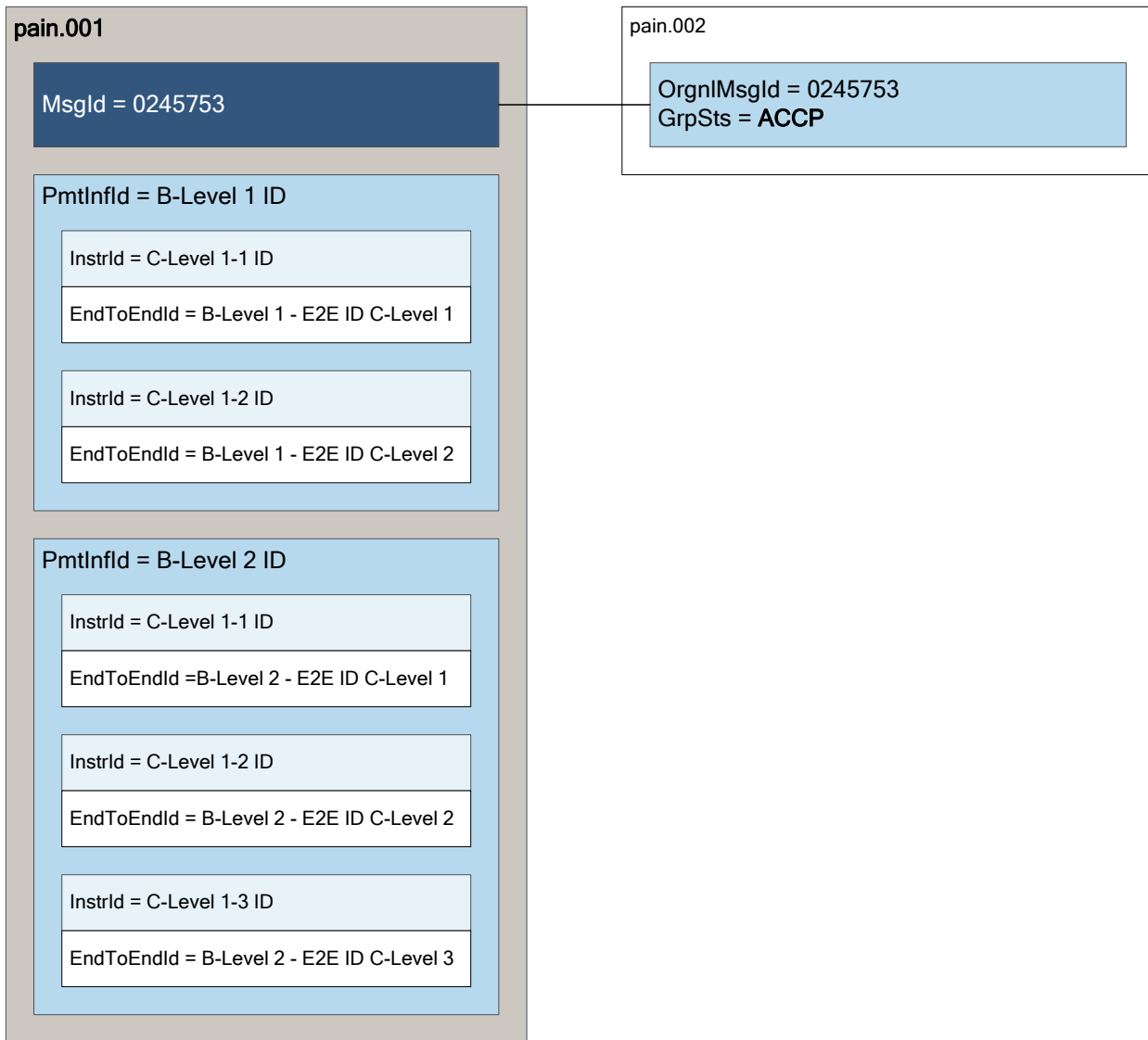

Figure 15: Example Status Report Accepted

**Example 2: Rejected – B-Level**

- pain.001: mandatory field at B-Level not correct (blank)
- pain.002: negative status report at Payment Information level

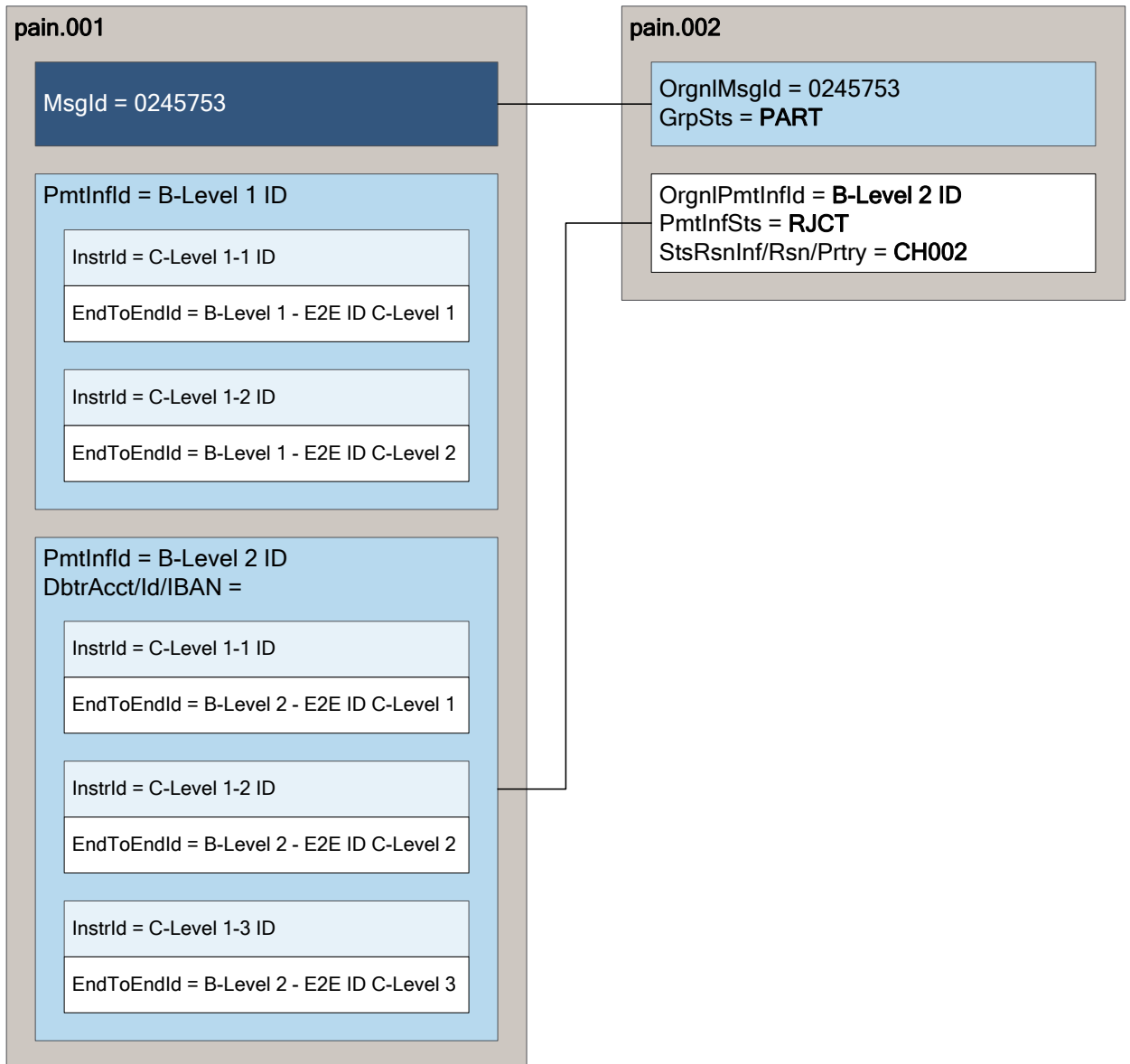

Figure 16: Example Status Report Rejected B-Level

**Note:** If B-Levels are delivered with different currencies or Charges/Instruction Priority at C-Level, these B-Levels may sometimes, in accordance with "Best Effort" be split by the financial institution, for example so that there is one booking per currency. In the event of this kind of B-Level being rejected, the B-Level reference of the submitting party is therefore no longer unique.

**Example 3: Rejected – C-Level**

pain.001: field sent incorrectly at C-Level (InstdAmt Ccy = XXX)

pain.002: negative status report at Transaction level

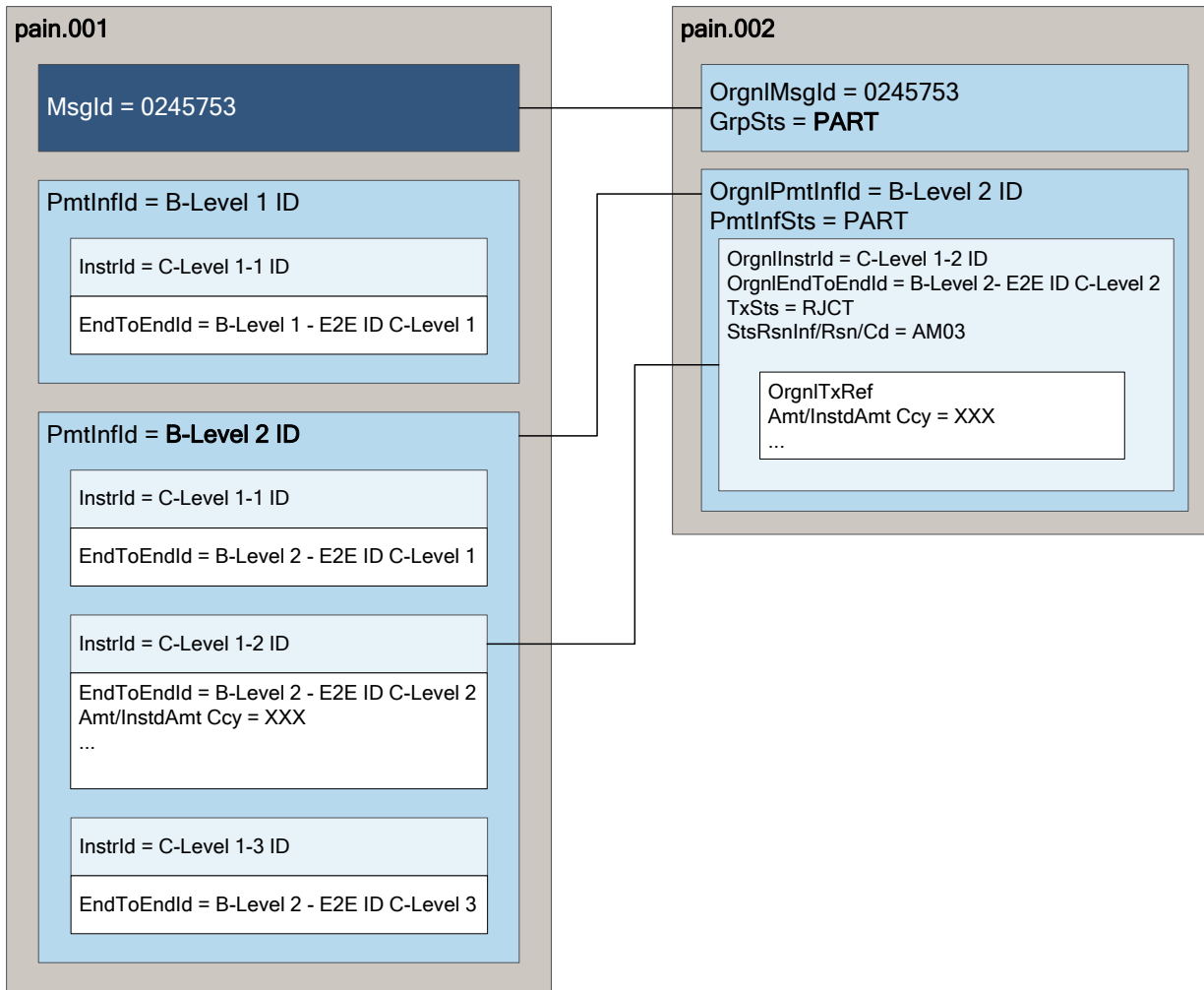

Figure 17: Example Status Report Rejected C-Level

## Appendix C: Symbols for graphical XML representation

### Expand and collapse symbols

Wherever parts of the tree structure can be expanded or collapsed, expand and collapse symbols are added to the symbols in the graphical representation. These consist of a small square containing either a plus sign or a minus sign.

- ⊕ Expand symbol: if you click on the plus sign the tree structure is expanded so subsequent symbols (attributes or child elements) are displayed. The expand symbol then changes to a collapse symbol.
- ⊖ Collapse symbol: if you click on the minus sign, the tree structure is collapsed again, i.e. the subsequent symbols disappear again. The collapse symbol then changes to an open symbol again.

### Elements





Elements are shown as rectangles containing the name of the element. For mandatory elements, the rectangle is shown with a continuous line, for optional elements the line is dotted.

For complex elements, which, unlike simple elements could contain attributes or other elements (so-called child elements), the rectangle has an expand or collapse symbol on the right.

Three little lines in the top left corner of the rectangle indicate that the element contains data (otherwise the element contains child elements).

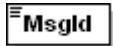
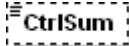
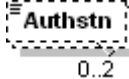
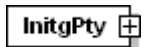
Elements which are allowed to occur more than once are shown as 2 superimposed rectangles. Bottom right, you can see the minimum and maximum number of occurrences.

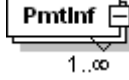
Examples:

|   |   |
|---|---|
|  | Mandatory simple element  |
|  | Optional simple element   |
|  | Optional simple element which can occur a maximum of twice                          |
|  | Mandatory complex element (with child elements) with collapsed tree structure       |
|  | Mandatory complex element (with child elements) with expanded tree structure        |
|  | Mandatory complex element (with child elements) which can occur any number of times |
|  | Mandatory complex element (with attributes)   |

**Attributes**

Attributes are also shown as rectangles, containing the name of the attribute. They are surrounded by a box containing the word "attributes" and an expand or collapse symbol. For mandatory attributes, the rectangle is drawn with a continuous line, for optional attributes the line is dotted.

Example:

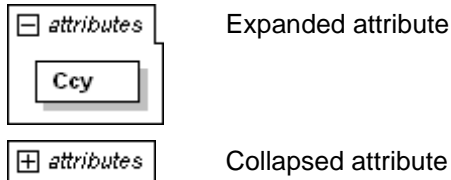

**Choice**

To the right of a choice symbol, the connecting lines branch off to the possible elements, of which only one can be present in the XML message.



**Sequence**

To the right of a sequence symbol, the connecting lines branch off to the elements which are to be used in the XML message in the order shown (optional elements and attributes can of course also be omitted).

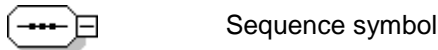

**Frame**

For increased clarity, all the child elements, attributes and other information belonging to a complex element are surrounded by a dotted frame with a yellow shaded background.

Example:

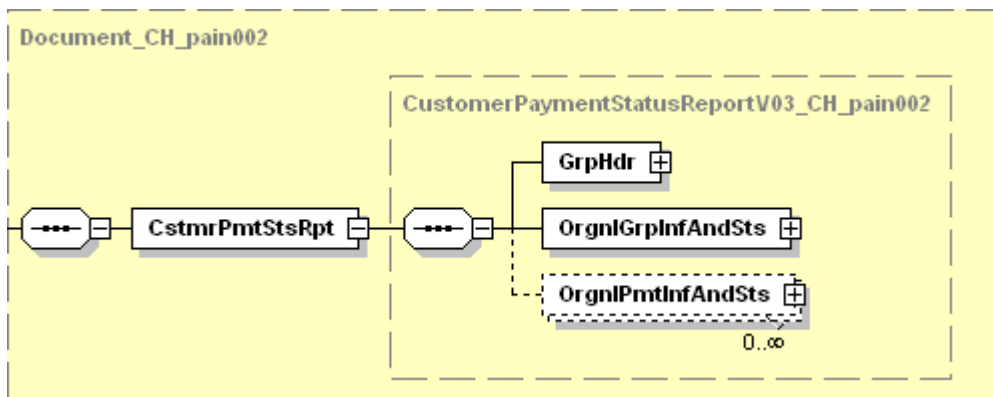



## Appendix D: Basis for the Swiss recommendations

The Swiss recommendations (Business Rules and these Implementation Guidelines for Status Report) are based on documents from ISO and EPC.

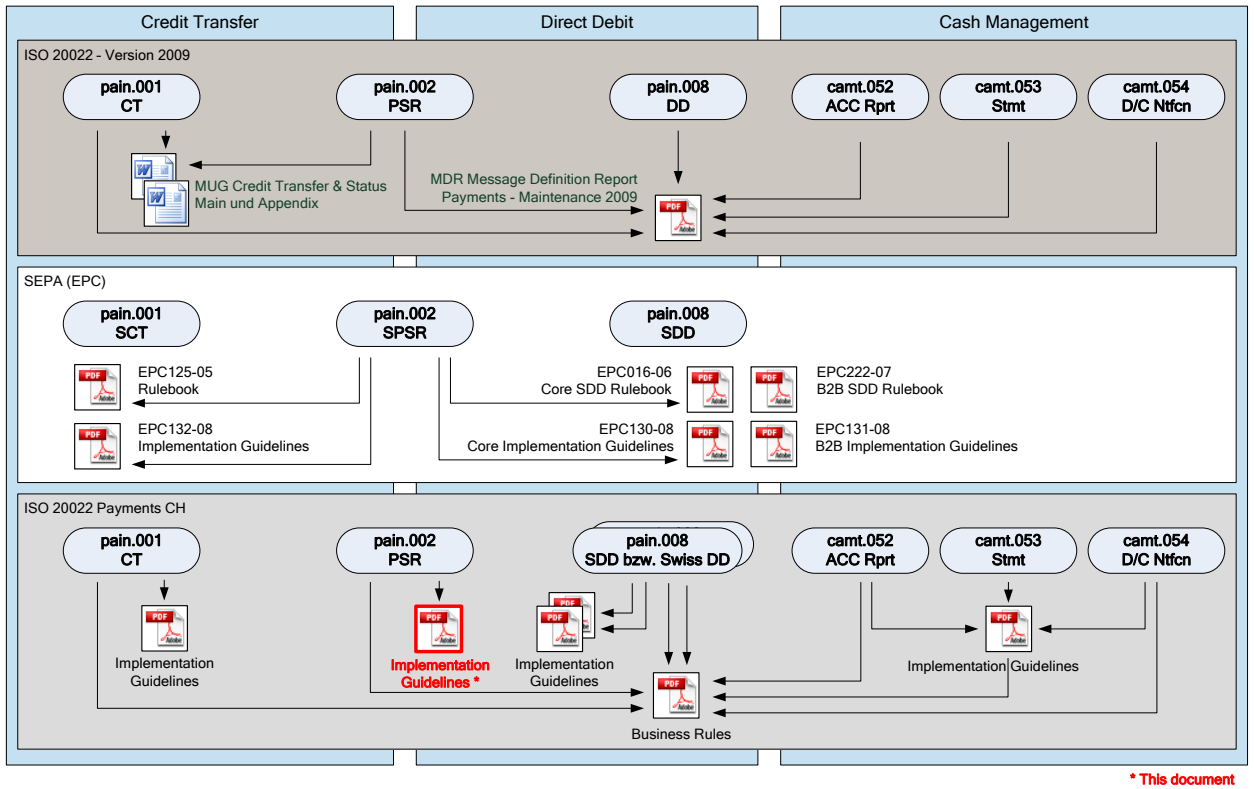

Figure 18: Basis for the Swiss recommendations

## Appendix E: Table of tables

|           |   |    |
|-----------|---|----|
| Table 1:  | Reference documents .....   | 6  |
| Table 2:  | Links to the relevant Internet pages .....  | 6  |
| Table 3:  | Group Header (GrpHdr, A-Level) .....  | 17 |
| Table 4:  | Original Group Information And Status (OrgnIGrpInfAndSts, B-Level) .....            | 20 |
| Table 5:  | Original Payment Information and Status (OrgnPmtInfAndSts, C-Level) .....           | 23 |
| Table 6:  | Transaction Information And Status (TxInfAndSts, D-Level) .....                     | 27 |
| Table 7:  | Status Reason Codes used in Switzerland .....                                       | 29 |
| Table 8:  | Status categories .....   | 31 |
| Table 9:  | Additional status .....   | 31 |
| Table 10: | Dependencies of Group Status and Payment Information Status .....                   | 32 |
| Table 11: | Example of the degree of detail in a status report .....                            | 36 |
| Table 12: | Summary matrix for errors in "pain.001" in relation to statuses in "pain.002" ..... | 39 |
| Table 13: | Group Status .....  | 40 |
| Table 14: | Payment Information Status .....  | 40 |
| Table 15: | Transaction Status .....  | 41 |

## Appendix F: Table of figures

|            |   |    |
|------------|---|----|
| Figure 1:  | Payment Initiation message flow - summary .....   | 7  |
| Figure 2:  | Degree of concordance between the Swiss ISO 20022 Payments Standards and ISO 20022 and SEPA ..... | 8  |
| Figure 3:  | Example of graphical representation of an XML message .....                                       | 10 |
| Figure 4:  | Using the Swiss XML schema .....  | 12 |
| Figure 5:  | Basic message structure for the "pain.002" XML message .....                                      | 15 |
| Figure 6:  | Group Header (GrpHdr) .....   | 16 |
| Figure 7:  | Original Group Information And Status (OrgnIGrpInfAndSts) .....                                   | 18 |
| Figure 8:  | Original Payment Information And Status (OrgnPmtInfAndSts) .....                                  | 21 |
| Figure 9:  | Transaction Information And Status (TxInfAndSts) .....  | 24 |
| Figure 10: | Summary of possible statuses in the Status Report .....   | 30 |
| Figure 11: | Basic scheme for mapping "pain.001" on to "pain.002" .....  | 35 |
| Figure 12: | Errors at "pain.001" A-Level – References in "pain.002" .....                                     | 37 |
| Figure 13: | Errors at "pain.001" B-Level – References in "pain.002" .....                                     | 37 |
| Figure 14: | Errors at "pain.001" C-Level – References in "pain.002" .....                                     | 38 |
| Figure 15: | Example Status Report Accepted .....  | 44 |
| Figure 16: | Example Status Report Rejected B-Level .....  | 45 |
| Figure 17: | Example Status Report Rejected C-Level .....  | 46 |
| Figure 18: | Basis for the Swiss recommendations .....   | 49 |