



# ISO 20022 Payments

Swiss Business Rules  
for Payments and Cash Management  
for Customer-Bank Messages



### **General note**

Any suggestions or questions relating to this document should be addressed to the financial institution in question or to SIX Interbank Clearing Ltd at the following address: [pm@six-group.com](mailto:pm@six-group.com).

### **Amendment control**

All the amendments carried out on this document are listed in an amendment record table showing the version, the date of the amendment and a brief amendment description.

### **Change of name from "BC number" (BC No.) to "Institutional identification" (IID)**

The concept of the BC number, short for Bank Clearing Number, has been out-of-date since at least 2010, when the Swiss National Bank provided access to the SIC system also to participants without the status of a bank, such as insurance companies. Furthermore, this number is used not only for the clearing of payments, but also for information that goes beyond the various payment traffic infrastructures. One example is the function of the BC number as part of the IBAN, a form of bank account number that can be used for many purposes.

This is why the Swiss recommendations will in future use "IID" (institutional identification) instead of "BC no.".

---

## Amendment control

---

<b>Version</b>	<b>Date</b>	<b>Amendment description</b>
1.0	15.05.2009	First edition (only German version)
2.0	15.02.2010	Updating of recommendations to comply with ISO MR 2009, Additional information about Cash Management (only German version)
2.1	01.06.2010	Additions relating to the Status Report
2.2	16.08.2011	Amendments to Cash Management messages, general updating of the document
2.3	30.04.2012	Various clarifications, section 6.10 "Validation point" completely revised, new company logo
2.4	30.06.2013	Various clarifications
2.5	10.08.2015	General updating of the document
2.6	25.07.2016	Title page and colour scheme for tables and illustrations amended to comply with the new Brand Identity Guidelines. Various textual changes/standardisations throughout the document. Explanation of the change from BC no. to IID added to the Foreword. Section "Payment Status Report (pain.002)" removed to separate Implementation Guidelines.

---

## Table of contents

<b>1</b>	<b>Introduction .....</b>	<b>7</b>
1.1	Amendment control .....	7
1.2	Scope .....	8
1.2.1	Elements with no relevance to Swiss recommendations .....	8
1.2.2	Additional Optional Services (AOS) .....	8
1.2.3	Direct Debit .....	9
1.3	Benefits .....	10
1.4	Reference documents .....	11
1.5	Interface versions .....	13
1.6	Links to the relevant Internet pages .....	13
<b>2</b>	<b>Business situations .....</b>	<b>14</b>
2.1	Credit Transfer Initiation .....	14
2.1.1	Transfers to a financial institution in Switzerland .....	14
2.1.2	Transfers to a financial institution abroad .....	15
2.1.3	Payments not involving a financial institution in Switzerland or abroad .....	16
2.1.4	Look ahead to "Payment slip with QR code" (with effect from 2018) .....	17
2.2	Direct Debit Initiation .....	19
2.2.1	Direct Debit Initiation for the SEPA direct debit procedure .....	19
2.2.2	Direct Debit Initiation for the Swiss direct debit procedure .....	19
2.3	Cash Management messages .....	19
<b>3</b>	<b>Message structure and summary .....</b>	<b>20</b>
3.1	Summary of message flow .....	20
3.2	Message structure Customer Credit Transfer Initiation .....	21
3.3	Message structure Customer Direct Debit Transfer Initiation .....	23
3.4	Message structure Payment Status Report .....	25
3.5	Message structure Cash Management messages .....	27
<b>4</b>	<b>Customer Credit Transfer Initiation .....</b>	<b>30</b>
4.1	Principles of message structure .....	30
4.1.1	Treatment of B- and C-Level in Customer Credit Transfer .....	30
4.1.2	Inheritance of instructions .....	30
4.1.3	Elements which have no relevance to the Swiss recommendations .....	30
4.2	Grouping of payments .....	31
4.2.1	Survey .....	31
4.2.2	Forming groups .....	32
4.2.3	Grouping based on "Payment Type Information" .....	32
4.3	Booking information (Batch Booking) .....	33
4.3.1	Use of Batch Booking in Switzerland .....	33
4.4	Customer Credit Transfer Initiation references .....	35
4.5	Instructions (Payment Instruments) .....	40
4.5.1	Overview .....	40
4.5.2	Applying the instructions in Switzerland .....	40
4.6	Identification of the parties involved .....	43

4.6.1	Identification of financial institutions .....	43
4.6.2	Identification of debtor and creditor .....	44
4.6.3	Identification of "Ultimate" Debtor and Creditor .....	45
4.7	Controlling the debit advice (Debtor Account Type) .....	46
4.8	Limiting the message size .....	47
4.9	Character set .....	47
4.10	Checking for duplicates .....	48
4.11	Salary/pension flag (Element Category Purpose <CtgyPurp>) .....	48
4.11.1	Controlling the notification .....	48
4.12	Version for cheques and payment instructions (postal mandate) .....	50
4.13	Definitions of specific elements .....	51
4.13.1	Requested Execution Date element .....	51
4.13.2	Instruction for Debtor Agent and Creditor Agent element .....	51
4.13.3	Control Sum .....	52
<b>5</b>	<b>Customer Direct Debit Initiation .....</b>	<b>53</b>
5.1	Handling B- and C-Levels in Direct Debit .....	53
<b>6</b>	<b>Customer Payment Status Report (pain.002) .....</b>	<b>54</b>
<b>7</b>	<b>General statement on the introduction .....</b>	<b>55</b>
7.1	Transitional scenarios .....	55
7.2	Date of introduction for financial institutions .....	55
<b>8</b>	<b>Central validation point .....</b>	<b>56</b>
<b>9</b>	<b>Business Rules Customer Cash Management .....</b>	<b>58</b>
9.1	"camt" messages – the future of electronic account information .....	58
9.2	Messages according to the Swiss recommendations .....	58
9.3	Principles of message structure .....	59
9.3.1	Handling B-, C- and D-Levels .....	59
9.4	Different versions of camt.052, camt.053 and camt.054 .....	60
9.5	Size restriction .....	60
9.6	Referencing certain messages .....	60
9.7	Breakdown of batch bookings (pain.001, pain.008) .....	61
9.7.1	Batch booking scenarios .....	61
9.7.2	Possible batch booking breakdown .....	61
9.8	Definitions of specific elements on the basis of camt.053 .....	62
9.8.1	Balance <Bal>, B-Level .....	63
9.8.2	Balance Type <Tp>, B-Level .....	63
9.8.3	Entry Status <Sts>, C-Level .....	64
9.8.4	Bank Transaction Code <BkTxCd>, C-Level .....	64
9.8.5	References <Refs>, D-Level .....	65
9.8.6	Bank Transaction Code <BkTxCd>, D-Level .....	66
9.8.7	Purpose <Purp>, D-Level .....	66
9.8.8	Remittance Information <RmtInf>, D-Level .....	66
9.9	Bank to Customer Account Report (camt.052) .....	67
9.9.1	Balance <Bal>, B-Level .....	67
9.9.2	Entry Status <Sts>, C-Level .....	67
9.10	Bank to Customer Debit Credit Notification (camt.054) .....	68



9.10.1	Reporting Source <RptgSrc> <Prtry>, B-Level .....	68
9.10.2	Balance <Bal>, B-Level .....	68
9.10.3	Entry Status <Sts>, C-Level .....	68
<b>Appendix A: Comparison camt.053 – MT940 .....</b>		<b>69</b>
<b>Appendix B: References in Cash Management Report .....</b>		<b>70</b>
<b>Appendix C: AOS list .....</b>		<b>71</b>
<b>Appendix D: Basis for the Swiss recommendations .....</b>		<b>72</b>
<b>Appendix E: Glossary and list of abbreviations .....</b>		<b>73</b>
<b>Appendix F: Table of tables .....</b>		<b>75</b>
<b>Appendix G: Table of figures .....</b>		<b>76</b>

# 1 Introduction

---

The Swiss recommendations for implementing the message standards for Payments Initiation and Cash Management based on ISO standard 20022 have been produced on the instructions of PaCoS (Payments Committee Switzerland), a committee under the Swiss Payments Council (SPC). This version is based on the ISO Maintenance Release 2009 and the latest EPC recommendations, and for Cash Management on the "ISO Maintenance Release 2013" version.

The Swiss recommendations consist of the following documents:

- Swiss Business Rules (this document)
- Swiss Implementation Guidelines
  - for Credit Transfer (pain.001)
  - for the Swiss direct debit procedure (pain.008)
  - for the SEPA direct debit procedure (pain.008)
  - for Cash Management messages (camt.052, camt.053 and camt.054)
  - for Status Report (pain.002)
- Swiss Usage Guide (use cases and examples)

The first document, the **Business Rules**, describes the requirements of business representatives of users, financial institutions and software providers, from the point of view of processes. It discusses the following subjects:

- Definition and description of specific business transactions, describing the relevant parties and the messages that are used (types of payments, versions of reports)
- Summary of message structures with more detail about certain structural elements
- Description of the main validation rules and ways of handling errors.

The **Implementation Guidelines** serve as manuals for the technical implementation of the standard and provide assistance in producing the various message types. They describe the XML structures and validation rules in detail.

The **Swiss Usage Guide** provides field rules and examples to explain the most frequent use cases (payment types) and explains how ISO 20022 messages (customer-bank or bank-customer) should be structured according to the Swiss recommendations, so providing an end-to-end overview of the whole process.

## 1.1 Amendment control

---

The Swiss Business Rules and Implementation Guidelines documents are subject to the amendment authority of

SIX Interbank Clearing Ltd  
 Hardturmstr. 201  
 CH-8021 Zurich

and reflect the regulations of Swiss financial institutions. Any future amendments and additions will be made by SIX Interbank Clearing by agreement with the Swiss financial services industry.

The latest version of this document can be downloaded from the SIX Interbank Clearing website at the following address: [www.iso-payments.ch](http://www.iso-payments.ch)

## 1.2 Scope

As mentioned in the title, this document deals with messages for Payment Transactions (pain) and Cash Management (camt). The following messages are described:<sup>1</sup>

- Customer Credit Transfer Initiation (ISO pain.001)
- Customer Direct Debit Initiation (ISO pain.008)
- Customer Payment Status Report (ISO pain.002), referred to below as the Payment Status Report
- Customer Account Report (ISO camt.052)
- Customer Statement (ISO camt.053)
- Customer Debit/Credit Notification (ISO camt.054)

The document mainly describes the exchange of messages between the customer (in references to MT950, a financial institution is intended as the customer) and the financial institution. The role of clearing systems (ACH) and the exchange of messages between financial institutions (interbank messages, pacs.nnn) do not form part of this document. They are only discussed in so far as this is required in order to describe the Business Rules.

The financial institutions have committed themselves as far as possible to joint rules on message validation and to providing standardised status and error messages. With regard to the way orders are processed (e.g. cut-off times, the handling of specific attributes such as how partially incorrect orders are processed or how particular order statuses are acknowledged etc.), the approach may vary between specific institutions.

### 1.2.1 Elements with no relevance to Swiss recommendations

Those elements which are not described in the Business Rules and Implementation Guidelines for the Swiss recommendations must not be used without consulting the financial institution (using these elements can lead to rejection of the whole message during schema validation). In specific cases, an AOS (Additional Optional Service) can be agreed with financial institutions for one specific element which is only processed within that financial institution.

### 1.2.2 Additional Optional Services (AOS)

- AOS** In general, the recommendations in this document are supported by all Swiss financial institutions. Additional services which are not always handled in the same way are identified as "Additional Optional Services" (AOS) and are marked as shown here in the relevant places.

<sup>1</sup> The terms "document" and "message" are sometimes used synonymously. In the context of ISO 20022 C2B they refer for instance to an account statement or to the instruction by the ordering party, comprising one or more payments, which are sent to the financial institution in a transfer packet (like the DTA or EPO file).



### 1.2.3 Direct Debit

---

The subject of the SEPA direct debit procedure and the Swiss direct debit procedure and so also the "Customer to Bank Direct Debit Initiation" (pain.008) message are not described again fully in this document, because most of the elements have the same meaning as in the "Customer Credit Transfer Initiation" message. So the definitions listed here for the "pain.001" message also apply in principle to the "pain.008" message, while the Status Report (pain.002) is used by Swiss financial institutions according to these definitions both as a response message in Credit Transfer (to a "pain.001") and also in Direct Debit (to a "pain.008").

**Comment:** For the time being, SEPA Direct Debit is not intended to replace the financial institutions' existing national direct debit messages and processes. SEPA Direct Debit is offered in parallel to the existing national processes. Validation and processing are in accordance with the latest version of the definitions of the European Payments Council (EPC) ([www.europeanpaymentscouncil.eu](http://www.europeanpaymentscouncil.eu)). The list of financial institutions participating in the process is also published on the EPC website.

---

## 1.3 Benefits

---

The international application of ISO 20022 (XML) offers participants in the market a number of advantages which will help the standard to become established (see the initiatives by EPC, SWIFT etc.). Especially in terms of electronic interfaces, XML format is widely established and is well-known among software providers.

The international use of a common standard for electronic payment transactions and for Cash Management Reporting opens up tremendous potential benefits for all parties involved, including

- the possibility (optional) of supporting complex order types
- standard message types (less complex development, maintenance and updating work required by software partners)
- standardised validation processes, i.e. the same quality standards can be applied to orders by all financial institutions. This increases flexibility, for example in working with more than one financial institution.
- standardised status and error codes (simpler communication with support centres, regardless of software provider or financial institution)
- standardised bank transaction codes (simpler identification of account movements beyond institutional boundaries)
- end-to-end customer references (with more characters than are used today). This enables automation with regard to debtors and creditors.
- fewer processing errors (rejects) thanks to consistent message standards
- use of a common nomenclature and terminology among participants in the market.
- support for the SEPA scheme used in Europe and for the ISO 20022 standard
- greater flexibility if messages need to be extended, thanks to use of the XML format (compared with the fixed length message type in widespread use today)
- reduction in some of the present shortcomings:
  - large number of different types of records for DTA and EPO (incl. different field lengths)
  - different parameters and processing rules for submitting orders
  - different message validation processes, status and error messages
  - proprietary business transaction codes used in reporting by particular financial institutions

## 1.4 Reference documents

Ref	Document	Title	Source
	<b>Base documents</b>		
[1]	Payments Maintenance 2009	Message Definition Report, Approved by the Payments SEG on 30 March 2009, Edititon September 2009	ISO
[2]	pain.001.001.03	XML Schema CustomerCreditTransferInitiationV03	ISO
[3]	pain.008.001.02	XML Schema CustomerDirectDebitInitiationV02	ISO
[4]	pain.002.001.03	XML Schema PaymentStatusReportV03	ISO
[5]	camt.052.001.02 camt.052.001.04	BankToCustomerAccountReportV02 BankToCustomerAccountReportV04	ISO
[6]	camt.053.001.02 camt.053.001.04	BankToCustomerStatementV02 BankToCustomerStatementV04	ISO
[7]	camt.054.001.02 camt.054.001.04	BankToCustomerDebitCreditNotificationV02 BankToCustomerDebitCreditNotificationV04	ISO
[8]	EPC125-05	SEPA Credit Transfer Scheme Rulebook Version 8.2	EPC
[9]	EPC132-08	SEPA Credit Transfer Scheme Customer-to-Bank Implementation Guidelines Version 8.0	EPC
[10]	EPC016-06	SEPA Core Direct Debit Scheme Rulebook Version 9.2	EPC
[11]	EPC130-08	SEPA Core Direct Debit Scheme Customer-to-Bank Implementation Guidelines Version 8.0	EPC
[12]	EPC222-07	SEPA Business to Business Direct Debit Scheme Rulebook Version 7.2	EPC
[13]	EPC131-08	SEPA Business to Business Direct Debit Scheme Customer-to-Bank Implementation Guidelines Version 7.0	EPC
[14]	IG CT	Swiss Implementation Guidelines for Customer-Bank Messages Credit Transfer (Payment Transactions)	SIX Interbank Clearing
[15]	IG Swiss-DD	Swiss Implementation Guidelines for Customer-Bank Messages for the Swiss direct debit procedure	SIX Interbank Clearing
[16]	IG SDD	Swiss Implementation Guidelines for Customer-Bank Messages for the SEPA Direct Debit Scheme	SIX Interbank Clearing
[17]	IG camt	Swiss Implementation Guidelines for Bank-Customer Messages (Reports)	SIX Interbank Clearing

Ref	Document	Title	Source
[18]	IG Status Report	Swiss Implementation Guidelines for Customer-Bank Messages Status Report	SIX Interbank Clearing
[19]	Swiss Usage Guide	Swiss Usage Guide for ISO 20022 messages complying with the Swiss recommendations	SIX Interbank Clearing
	<b>Additional documents</b>		
[20]	DTA Standards and Formats	Version 3.5/01.08.2009, <a href="http://www.dta.ch">www.dta.ch</a>	SIX Interbank Clearing
[21]	EPO Handbook	Edition: March 2011	Post Finance
[22]	Standards Cash Management Message Reference Guide	Cash Management for Standards MX Message Reference Guide, 24 July 2009	SWIFT

*Table 1: Reference documents*

## 1.5 Interface versions

The plan is to publish one "major" new version of the Swiss recommendations every year (if necessary). The Swiss financial institutions guarantee the following interface compatibility: that they will support the latest "Major" version of the Business Rules and Implementation Guidelines published by SIX Interbank Clearing plus the preceding version (i.e. always the two most recent Guideline versions in parallel).

**Comment:** If the customer delivers an order file in the latest XML schema version, then he will receive the Status Report in the same XML schema version. If the file is delivered in the previous version, the Status Report will also be sent back in the previous version. Mixing the XML schema versions is not possible. A response to a version which is no longer supported will be sent in the oldest supported version.

## 1.6 Links to the relevant Internet pages

Organisation	Link
ISO	<a href="http://www.iso20022.org">www.iso20022.org</a>
EPC	<a href="http://www.europeanpaymentscouncil.eu">www.europeanpaymentscouncil.eu</a>
SIX Interbank Clearing Ltd	<a href="http://www.iso-payments.ch">www.iso-payments.ch</a> , <a href="http://www.sepa.ch">www.sepa.ch</a> and <a href="http://www.six-interbank-clearing.com">www.six-interbank-clearing.com</a>
SWIFT	<a href="http://www.swift.com">www.swift.com</a>
PostFinance	<a href="http://www.postfinance.ch/epo">www.postfinance.ch/epo</a>

Table 2: Links to Internet pages

## 2 Business situations

### 2.1 Credit Transfer Initiation

The following tables group the business situations that may arise in payment traffic in Switzerland into various payment types. These payment types are subdivided into domestic and foreign transfers and payments with no creditor institution (payment instructions and cheques).

The colours and definitions used in the tables are as follows:

 Type of transaction

[1] Payment type number. The business situation is assigned to a payment type as described in the Implementation Guidelines.

 Payment slips (paying-in slips, cheques)

 Debtor (DEB, ordering party) details

 Creditor (CR, beneficiary) details

#### 2.1.1 Transfers to a financial institution in Switzerland

	Orange payment slip (ISR) in CHF & EUR [1]	Red payment slip (IS) in CHF & EUR [2]	Bank or postal payment in CHF & EUR [3]	Bank or postal payment in foreign currency excl. CHF & EUR* [4]
Payment slip	<ul style="list-style-type: none"> <li>ISR to credit postal account (1-stage slip)</li> <li>ISR to credit bank account (2-stage slip)</li> </ul>	<ul style="list-style-type: none"> <li>IS to credit postal account (1-stage slip) [2.1]</li> <li>IS to credit bank with IBAN (or bank account) (2-stage slip) [2.2]</li> </ul>	<ul style="list-style-type: none"> <li>No payment slip</li> </ul>	<ul style="list-style-type: none"> <li>No payment slip</li> <li>Poss. IPI slip (to provide information)</li> </ul>
Surname/first name, debtor's address	Mandatory			
Debtor's account number	<ul style="list-style-type: none"> <li>Presented to bank: IBAN (in exceptional cases the bank account no. is allowed)</li> <li>Presented to PostFinance: IBAN or postal account</li> </ul>			
Debtor's financial institution	IID or domestic BIC allowed			
Surname/first name, creditor's address	Optional	Mandatory	Mandatory	Mandatory
Creditor's account number	ISR participant number	<ul style="list-style-type: none"> <li>1-stage slip: postal account</li> <li>2-stage slip:                             <ul style="list-style-type: none"> <li>IBAN (or bank account)</li> <li>For optical reading of the "IS Bank": 27 positions from the 1st line of the encoding line (pos. 18-44)</li> </ul> </li> </ul>	<ul style="list-style-type: none"> <li>Bank payments: IBAN (in exceptional cases the bank account no. is allowed)</li> <li>Postal payments: IBAN or postal account</li> </ul>	<ul style="list-style-type: none"> <li>Bank payments: IBAN (in exceptional cases the bank account no. is allowed)</li> <li>Postal payments: IBAN or postal account</li> </ul>

	Orange payment slip (ISR) in CHF & EUR [1]	Red payment slip (IS) in CHF & EUR [2]	Bank or postal payment in CHF & EUR [3]	Bank or postal payment in foreign currency excl. CHF & EUR* [4]
Creditor's financial institution	No details	<ul style="list-style-type: none"> <li>1-stage slip: this field remains blank</li> <li>2-stage slip:                             <ul style="list-style-type: none"> <li>– IID</li> <li>– IID and postal account no. of the bank</li> <li>– postal account no. of the bank and name of the bank</li> </ul> </li> </ul>	IID (or domestic BIC)	<ul style="list-style-type: none"> <li>Domestic BIC (or name and address of the financial institution) or if available national bank code (IID).</li> </ul>
Payment currency	CHF or EUR	CHF and EUR	CHF and EUR	Foreign currencies* (i.e. all except CHF and EUR)
Execution date	Mandatory			
Fees	No details	No details	No details	<ul style="list-style-type: none"> <li>SHA</li> <li>OUR</li> <li>BEN</li> </ul>
Reference number, notification to creditor	ISR reference <ul style="list-style-type: none"> <li>Structured: Creditor Reference</li> </ul>	<ul style="list-style-type: none"> <li>Unstructured: notification/payment purpose</li> </ul>	<ul style="list-style-type: none"> <li>Unstructured: notification/payment purpose</li> <li>Structured: Creditor Reference and purpose</li> </ul>	
Notification to debtor's financial institution	To be used only by agreement with the financial institution	To be used only by agreement with the financial institution	To be used only by agreement with the financial institution	To be used only by agreement with the financial institution
Notification to creditor's financial institution	Not allowed	Not allowed	Not allowed	Possible

Table 3: Transactions going to a financial institution in Switzerland

### 2.1.2 Transfers to a financial institution abroad

	SEPA transfer [5]	All currencies* (SWIFT) [6]
Payment slip	<ul style="list-style-type: none"> <li>No payment slip</li> <li>IPI slip (to provide information)</li> </ul>	<ul style="list-style-type: none"> <li>No payment slip</li> <li>IPI slip (to provide information)</li> </ul>
Surname/first name, debtor's address	Mandatory	
Debtor's account number	<ul style="list-style-type: none"> <li>IBAN</li> </ul>	<ul style="list-style-type: none"> <li>IBAN (in exceptional cases the bank/postal account no. is allowed)</li> </ul>
Debtor's financial institution	Only IID or domestic BIC allowed	
Surname/first name, creditor's address	Mandatory	
Creditor's account number	IBAN	IBAN or bank account (always use IBAN in Europe)
Creditor's financial institution	BIC SEPA Explicitly naming the creditor's financial institution is not necessary where the IBAN is given in the Creditor Account. When the payment is processed, the creditor's financial institution is deduced from the IBAN.	<ul style="list-style-type: none"> <li>BIC International</li> <li>Name and address of the financial institution and where available national bank code (e.g. Fedwire).</li> </ul> (always use BIC in Europe)
Payment currency	EUR	All*
Execution date	Mandatory	

	SEPA transfer [5]	All currencies* (SWIFT) [6]
Fees	SLEV (share)	<ul style="list-style-type: none"> <li>• SHA</li> <li>• OUR</li> <li>• BEN</li> </ul>
Reference number, notification to creditor	<ul style="list-style-type: none"> <li>• Unstructured: notification/payment purpose</li> <li>• Structured: only Creditor Reference</li> </ul>	<ul style="list-style-type: none"> <li>• Unstructured: notification/payment purpose</li> <li>• Structured: Creditor Reference and purpose</li> </ul>
Notification to debtor's financial institution	To be used only by agreement with the financial institution	Possible
Notification to creditor's financial institution	Not allowed	Possible

Table 4: Transactions going to a financial institution abroad

### 2.1.3 Payments not involving a financial institution in Switzerland or abroad

	Domestic CHF postal orders [7]	Bank cheque/Postcash domestic and foreign in all currencies* [8]
Payment slip	No payment slip (amount will be transferred to the CR by the post)	Bank cheque is sent to the CR
Surname/first name, debtor's address	Mandatory	
Debtor's account number	<ul style="list-style-type: none"> <li>• Presented to bank: IBAN (in exceptional cases the bank account no. is allowed)</li> <li>• Presented to PostFinance: IBAN or postal account</li> </ul>	
Debtor's financial institution	Only IID or domestic BIC allowed	
Surname/first name, creditor's address	Mandatory	Mandatory
Creditor's account number	No details	No details
Creditor's financial institution	No details	No details
Payment currency	CHF	All
Execution date	Mandatory	
Fees	No details	<ul style="list-style-type: none"> <li>• SHA</li> <li>• OUR</li> <li>• BEN</li> </ul>
Reference number, notification to creditor	<ul style="list-style-type: none"> <li>• Structured: Creditor Reference and purpose</li> <li>• Unstructured: notification/payment purpose</li> </ul>	
Notification to debtor's financial institution	Not allowed	Possible
Notification to creditor's financial institution	Not allowed	Not allowed

Table 5: Transactions not involving a financial institution in Switzerland or abroad

The individual payment types for the Swiss recommendations are those supported in the ISO 20022 "pain.001" message.

**Comment:** For SEPA payments, EPC definitions have been taken into account.

**\*Note:** The actual range of currencies that are supported is to be clarified with the respective financial institution.



**Note:** It is up to the financial institutions whether they offer the "Bank cheque/Postcash domestic and foreign in all currencies\* [8]" payment type. The range of payment types that are actually available is described in institute-specific descriptions of services.

### 2.1.4 Look ahead to "Payment slip with QR code" (with effect from 2018)

Today's red and orange payment slips in all versions are due to be replaced by a payment slip with QR code (IS with QR code) or with reference number and QR code (ISR with QR code).

The replacement starts probably about mid-2018 and shall be terminated about mid-2020 (for exact dates see [www.paymentstandards.ch](http://www.paymentstandards.ch)). Banks will then be able to handle invoices from their customers using the new processing method involving the "pain.001" message. Creditors who are corporate customers will be able to convert to the payment slip with QR code during a parallel phase of operations. It is also envisaged that "camt" messages will be used for notifications (payment credits).

Empfangsschein / Récépissé / Ricevuta	Einzahlung / Versement / Versamento	Zahlungszweck / Motif versement / Motivo versamento
Einzahlung für / Versement pour / Versamento per <b>Seldwyla Bank</b> 8001 Zürich Zugunsten von / En faveur de / A favore di <b>Robert Schneider SA</b> Grands magasins Case postale 2501 Biel/Bienne Konto / Compte / Conto CH49 3199 9123 0007 8901 2 CHF 3949 . 75 Einbezahlt von / Versé par / Versato da <b>Rutschmann Pia</b> Marktgasse 28 9400 Rorschach Die Annahmestelle L'office de dépôt L'ufficio d'accettazione	Einzahlung für / Versement pour / Versamento per <b>Seldwyla Bank</b> 8001 Zürich Zugunsten von / En faveur de / A favore di <b>Robert Schneider SA</b> Grands magasins Case postale 2501 Biel/Bienne Konto / Compte / Conto CH49 3199 9123 0007 8901 2 CHF 3949 . 75 	Keine Mitteilungen anbringen Pas de communications Non aggiungete comunicazioni Referenz-Nr. / N° de référence / N° di riferimento 21 00000 00003 13947 14300 09017 Einbezahlt von / Versé par / Versato da <b>Rutschmann Pia</b> Marktgasse 28 9400 Rorschach

Figure 1: Prototype of the payment slip with reference number and QR code (ISR with QR code)

The payment slip with QR code will replace the existing payment type 1 (ISR) by the payment type E1 and the payment type 2.1 (IS 1-stage) by the payment type E2, while the payment type 2.2 (IS 2-stage) will no longer be used.

Data scanned from the QR code (data code) or recorded via e-banking will be transferred to the "pain.001" message as follows:

Data in the QR code of the payment slip with QR code				ISO 20022 pain.001
Index	Name	Status	Definition	Element in pain.001
2	IBAN / ISR-IBAN	M	IBAN or ISR-IBAN of the ultimate creditor. Each ultimate creditor participating in the procedure will have either an IBAN, for the procedure with notification, and/or an ISR-IBAN, for the procedure using a reference.	2.80 Creditor Account – IBAN
3	Ultimate creditor	M	Name of the ultimate creditor Note: this always refers to the account holder	2.79 Creditor – Name
		M	Post code of the ultimate creditor	2.79 Creditor – Post Code
		M	Location of the ultimate creditor (town)	2.79 Creditor – Town Name
		M	Country of the ultimate creditor	2.79 Creditor – Country
4	Amount	O	Amount of transfer	2.43 Instructed Amount
5	Currency	M	Currency of transfer	2.43 Instructed Amount
6	Debtor	O	Name of debtor	2.70 Ultimate Debtor – Name
		O	Street name of debtor	2.70 Ultimate Debtor – Street Name
		O	Building number of debtor	2.70 Ultimate Debtor – Building Number
		O	Post code of debtor	2.70 Ultimate Debtor – Post Code
		O	Location of debtor (town)	2.70 Ultimate Debtor – Town Name
		O	Country of debtor	2.70 Ultimate Debtor – Country
7	Reference number	D	The reference number can only be used in procedures with reference number. Note: the reference number is either an ISR reference or a Creditor Reference (ISO 11649)	2.126 Remittance Information – Reference
8	Purpose of payment	D	Notification of the purpose of the payment can only be used in procedures with notification.	2.99 Remittance Information – unstructured

Table 6: Transfer of data from the QR code to the "pain.001" message

## 2.2 Direct Debit Initiation

### 2.2.1 Direct Debit Initiation for the SEPA direct debit procedure

Based on the EPC recommendations for using the Customer Direct Debit Initiation message (ISO 20022 message "pain.008"), a version of the SEPA Direct Debit (Core and B2B) Scheme has been defined for Switzerland. This is an additional procedure and message type for collecting direct debits in the SEPA area, or for debiting collections from outside the SEPA area.

### 2.2.2 Direct Debit Initiation for the Swiss direct debit procedure

Based on the LSV<sup>+</sup>/BDD procedure and the "CH-DD" procedure, some financial institutions support the submission of direct debits using the ISO 20022 message "pain.008". The definition of the "pain.008" message that is used has been harmonised as far as possible.

**Note:** With the introduction of the new, common direct debit procedure (at the start of 2019), the two versions of the "pain.008"

- Version 1 for the CH-DD direct debit procedure and
- Version 2 for the LSV<sup>+</sup>/BDD procedure

will be joined by one unified version. This is based on a new referencing system for direct debits that allows the issuers of invoices to take advantage of many process improvements. The ultimate aim is that only the unified version based on the new referencing system will be available. Some financial institutions only offer the option of collecting direct debits under the ISO 20022 standard with this unified version.

## 2.3 Cash Management messages

Cash Management messages are used for reporting. Swiss financial institutions can offer the following message types:

ISO 20022 message	Application	SWIFT MT
camt.052	Bank to Customer Account Report (intra-day account transactions)	MT942, MT941
camt.053	Bank to Customer Statement (end-of-day account statement)	MT940, MT950
camt.054	Bank to Customer Debit/Credit Notification (debit/credit notification)	MT900, MT910

Table 7: Cash Management messages

### 3 Message structure and summary

#### 3.1 Summary of message flow

The following chart shows the parties involved and the message flows relating to payment orders under ISO 20022.

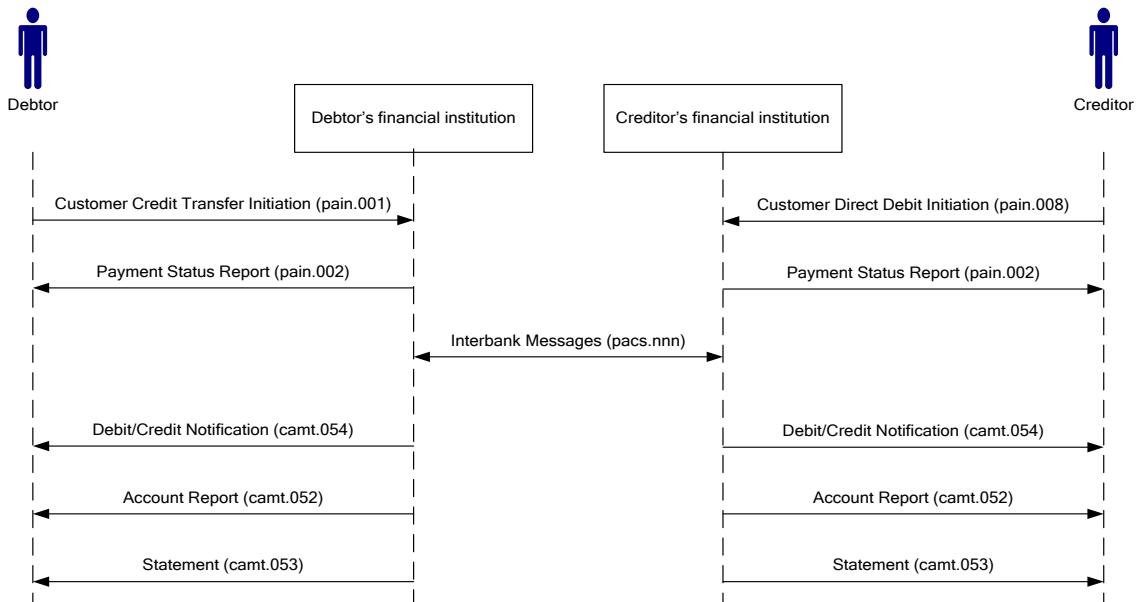

Figure 2: Payment orders under ISO 20022

This document describes the Business Rules for all messages from the customer to their financial institution and vice versa. Interbank messages (pacs.nnn) do not form part of this description.

<input checked="" type="checkbox"/> <b>AOS</b>	<b>Additional Optional Service</b>		<b>Explanation</b>
	Additional participants (e.g. in a multi-banking scenario)		The following table shows the additional participants.
	<b>Participant</b>	<b>Synonym</b>	<b>Description</b>
	Forwarding Agent	Multi-banking provider	E.g.: payment order sent to ZKB as the multi-bank provider with UBS as the debtor account
	Intermediary	Correspondent bank B	E.g.: financial institution A makes a transfer via correspondent bank B to financial institution C.

## 3.2 Message structure Customer Credit Transfer Initiation

The message is used on the basis of the ISO 20022 XML schema "pain.001.001.03".

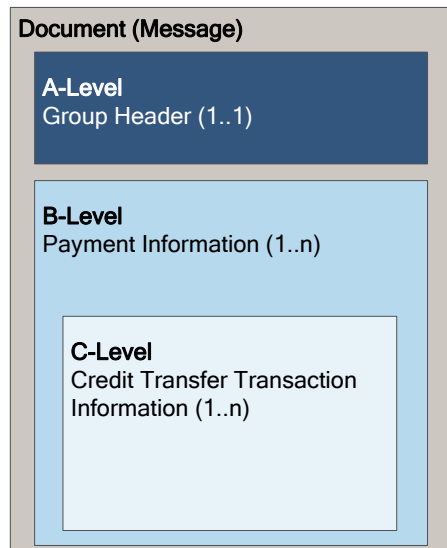

The message is structured as follows:

- **A-Level:** message level, Group Header
- **B-Level:** debtor side (debit side), Payment Information, information from the debtor (payer, DEB)
- **C-Level:** creditor side (credit side), Credit Transfer Transaction Information, information for the creditor (payee, CR)

Figure 3: Message structure Customer Credit Transfer Initiation

Level	Message item	Multiplicity
<b>A.</b>	<b>Group Header</b>	<b>[1...1]</b>
	Message Identification	[1...1]
	Creation Date Time	[1...1]
+	Authorisation	[0...2]
	Number Of Transactions	[1...1]
	Control Sum	[0...1]
+	Initiating Party	[1...1]
+	Forwarding Agent	[0...1]
<b>B.</b>	<b>Payment Information</b>	<b>[1...n]</b>
	Payment Information Identification	[1...1]
	Payment Method	[1...1]
	Batch Booking	[0...1]
	Number Of Transactions	[0...1]
	Control Sum	[0...1]
+	Payment Type Information	[0...1]
	Requested Execution Date	[1...1]
	Pooling Adjustment Date	[0...1]
+	Debtor	[1...1]
+	Debtor Account	[1...1]
+	Debtor Agent	[1...1]
+	Debtor Agent Account	[0...1]
+	Ultimate Debtor	[0...1]

Level	Message item	Multiplicity
	Charge Bearer	[0...1]
+	Charges Account	[0...1]
+	Charges Account Agent	[0...1]
<b>C.</b>	<b>Credit Transfer Transaction Information</b>	<b>[1...n]</b>
+	Payment Identification	[1...1]
+	Payment Type Information	[0...1]
+	Amount	[1...1]
+	Exchange Rate Information	[0...1]
	Charge Bearer	[0...1]
+	Cheque Instruction	[0...1]
+	Ultimate Debtor	[0...1]
+	Intermediary Agent1	[0...1]
+	Intermediary Agent1 Account	[0...1]
+	Intermediary Agent2	[0...1]
+	Intermediary Agent2 Account	[0...1]
+	Intermediary Agent3	[0...1]
+	Intermediary Agent3 Account	[0...1]
+	Creditor Agent	[0...1]
+	Creditor Agent Account	[0...1]
+	Creditor	[0...1]
+	Creditor Account	[0...1]
+	Ultimate Creditor	[0...1]
+	Instruction For Creditor Agent	[0...n]
+	Instruction For Debtor Agent	[0...1]
+	Purpose	[0...1]
+	Regulatory Reporting	[0...10]
+	Tax	[0...1]
+	Related Remittance Information	[0...10]
+	Remittance Information	[0...1]

Table 8: Key elements of Customer Credit Transfer Initiation

The detailed rules are described in section 4 "Customer Credit Transfer Initiation".

### 3.3 Message structure Customer Direct Debit Transfer Initiation

The message is used on the basis of the ISO 20022 XML schema "pain.008.001.02".

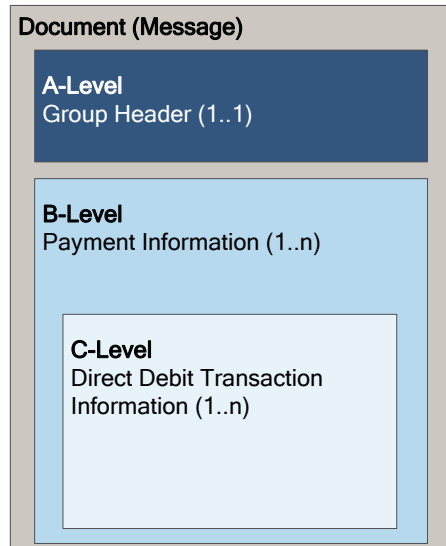

The message is structured as follows:

- A-Level: message level, Group Header
- B-Level: creditor side (credit side), Payment Information
- C-Level: debtor side (debit side), Direct Debit Transaction Information

Figure 4: Message structure Customer Direct Debit Initiation

Level	Message item	Multiplicity
<b>A.</b>	<b>Group Header</b>	<b>[1...1]</b>
	Message Identification	[1...1]
	Creation Date Time	[1...1]
+	Authorisation	[0...2]
	Number Of Transactions	[1...1]
	Control Sum	[0...1]
+	Initiating Party	[1...1]
+	Forwarding Agent	[0...1]
<b>B.</b>	<b>Payment Information</b>	<b>[1...n]</b>
	Payment Information Identification	[1...1]
	Payment Method	[1...1]
	Batch Booking	[0...1]
	Number Of Transactions	[0...1]
	Control Sum	[0...1]
+	Payment Type Information	[0...1]
	Requested Execution Date	[1...1]
	Pooling Adjustment Date	[0...1]
+	Creditor	[1...1]
+	Creditor Account	[1...1]
+	Creditor Agent	[1...1]
+	Creditor Agent Account	[0...1]
+	Ultimate Creditor	[0...1]

Level	Message item	Multiplicity
	Charge Bearer	[0...1]
+	Charges Account	[0...1]
+	Charges Account Agent	[0...1]
+	Creditor Scheme Identification	[0...1]
<b>C.</b>	<b>Direct Debit Transaction Information</b>	<b>[1...n]</b>
+	Payment Identification	[1...1]
+	Payment Type Information	[0...1]
+	Instructed Amount	[1...1]
	Charge Bearer	[0...1]
+	Direct Debit Transaction	[0...1]
+	Ultimate Creditor	[0...1]
+	Debtor Agent	[0...1]
+	Debtor Agent Account	[0...1]
+	Debtor	[0...1]
+	Debtor Account	[0...1]
+	Ultimate Debtor	[0...1]
+	Instruction For Creditor Agent	[0...n]
+	Purpose	[0...1]
+	Regulatory Reporting	[0...10]
+	Tax	[0...1]
+	Related Remittance Information	[0...10]
+	Remittance Information	[0...1]

Table 9: Key elements of Customer Direct Debit Initiation

The detailed rules are described in section 5 "Customer Direct Debit Initiation".



### 3.4 Message structure Payment Status Report

The message is used on the basis of the ISO 20022 XML schema "pain.002.001.03".

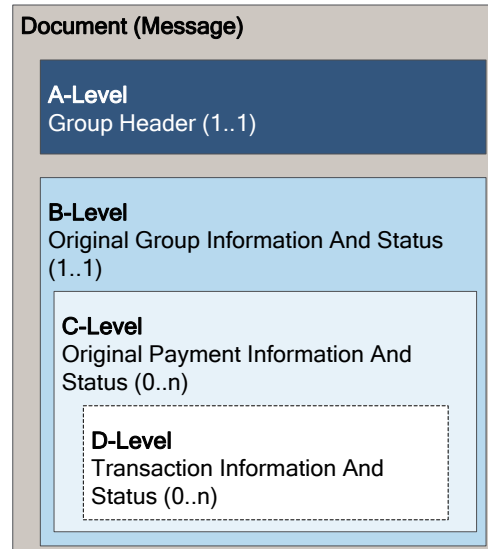

The message is structured as follows:

- A-Level: message level, Group Header
- B-Level: information about the payment group, Original Group Information And Status
- C-Level: information about specific payment groups (B-Level), Original Payment Information And Status
- D-Level: information about specific transactions (C-Level), Transaction Information And Status

Figure 5: Message structure Payment Status Report

Level	Message item	Multiplicity
<b>A</b>	<b>Group Header</b>	<b>[1..1]</b>
	Message Identification	[1..1]
	Creation Date Time	[1..1]
+	Initiating Party	[0..1]
+	Forwarding Agent	[0..1]
+	Debtor Agent	[0..1]
+	Creditor Agent	[0..1]
<b>B</b>	<b>Original Group Information And Status</b>	<b>[1..1]</b>
	Original Message Identification	[1..1]
	Original Message Name Identification	[1..1]
	Original Creation Date Time	[0..1]
	Original Number Of Transactions	[0..1]
	Original Control Sum	[0..1]
	Group Status	[0..1]
+	Status Reason Information	[0..n]
+	Number Of Transactions Per Status	[0..n]
<b>C</b>	<b>Original Payment Information And Status</b>	<b>[0..n]</b>
+	Original Payment Information Identification	[1..1]
+	Original Number Of Transactions	[0..1]
+	Original Control Sum	[0..1]
+	Payment Information Status	[0..1]

Level	Message item	Multiplicity
+	Status Reason Information	[0..n]
+	Number Of Transactions Per Status	[0..n]
<b>D</b>	<b>Transaction Information And Status</b>	<b>[0..n]</b>
	Status Identification	[0..1]
+	Original Instruction Identification	[0..1]
+	Original End To End Identification	[0..1]
+	Transaction Status	[0..1]
+	Status Reason Information	[0..n]
+	Charges Information	[0..n]
+	Acceptance Date Time	[0..1]
+	Account Service Reference	[0..1]
+	Clearing System Reference	[0..1]
+	Original Transaction Reference	[0..1]

Table 10: Key elements of Payment Status Report

### 3.5 Message structure Cash Management messages

The messages "camt.052" Account Report, "camt.053" Statement and "camt.054" Debit/ Credit Notification are used for reporting. They are used on the basis of the ISO 20022 XML schemas, either from ISO Release 2009 (as in SEPA) as "camt.052.001.02", "camt.053.001.02" and "camt.054.001.02" or from ISO Release 2013 as "camt.052.001.04", "camt.053.001.04" and "camt.054.001.04".

Swiss financial institutions will support the "camt" version .02 (ISO Release 2009) until the middle of 2018, and thereafter only the "camt" version .04 (ISO Release 2013).

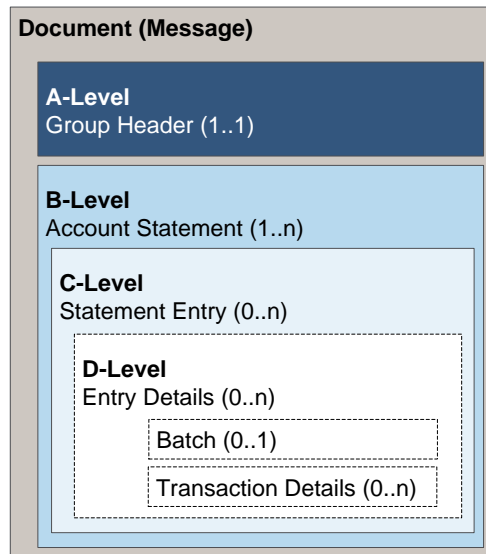

The message is structured as follows:

- A-Level: message level, Group Header
- B-Level: account level, Account Statement
- C-Level: amount level, Statement Entry
- D-Level: amount details, Entry Details

Figure 6: Message structure Cash Management messages

**Comment:** In what follows, the message "camt.053.001.02" (Statement, end-of-day statement) is described first, because this is the most frequently used message in Switzerland. For the "camt.052" (Account Report, intraday account transactions) and "camt.054" (Debit/Credit Notification) messages, only the variations are described.

Level	Message item	Multiplicity
<b>A</b>	<b>Group Header</b>	<b>[1...1]</b>
	Message Identification	[1...1]
	Creation Date Time	[1...1]
+	Message Recipient	[0...1]
	Message Pagination	[0...1]
	Page Number	[1...1]
	Last Page Indicator	[1...1]
	Additional Information	[0...1]
<b>B</b>	<b>Statement</b>	<b>[1...n]</b>
	Identification	[0...1]
	Electronic Sequence Number	[0...1]
	Legal Sequence Number	[0...1]
	Creation Date Time	[1...1]

Level	Message item	Multiplicity
+	From To Date	[0..1]
	From Date Time	[1..1]
	To Date Time	[1..1]
	Copy Duplicate Indicator	[0..1]
+	Account	[1..1]
+	Related Account	[0..1]
+	Interest	[0..n]
+	Balance	[1..n]
+	Transaction Summary	[0..1]
<b>C</b>	<b>Entry</b>	<b>[0..n]</b>
	Entry Reference	[0..1]
	Amount	[1..1]
	Credit Debit Indicator	[1..1]
	Reversal Indicator	[0..1]
	Status	[1..1]
+	Booking Date	[0..1]
+	Value Date	[0..1]
	Account Service Reference	[0..1]
+	Availability	[0..n]
+	Bank Transaction Code	[1..1]
	Commission Waiver Indicator	[0..1]
+	Additional Information Indicator	[0..1]
+	Amount Details	[0..1]
+	Charges	[0..n]
+	Technical Input Channel	[0..n]
+	Interest	[0..n]
<b>D</b>	<b>Entry Details</b>	<b>[0..n]</b>
+	Batch	[0..n]
	Transaction Details	[0..n]
+	References	[0..1]
+	Amount Details	[0..1]
+	Availability	[0..1]
+	Bank Transaction Code	[0..1]
+	Charges	[0..n]
+	Interest	[0..n]
+	Related Parties	[0..1]
+	Related Agents	[0..1]
+	Purpose	[0..1]
+	Related Remittance Information	[0..10]
+	Remittance Information	[0..1]
+	Related Dates	[0..1]
+	Related Prices	[0..1]

Level	Message item	Multiplicity
+	Related Quantities	[0...n]
+	Financial Instrument Identification	[0...1]
+	Tax	[0...1]
+	Return Information	[0...1]
+	Corporate Action	[0...1]
+	Safekeeping Account	[0...1]
	Additional Transaction Information	[0...1]
	Additional Entry Information	[0...1]
	Additional Entry Information	[0...1]

Table 11: Key elements of Cash Management message "camt.053"

The ISO version "camt.053.001.04" of "camt" messages also supports a new element called "Record" under "Transaction Details/Charges" which gives details of the fees:

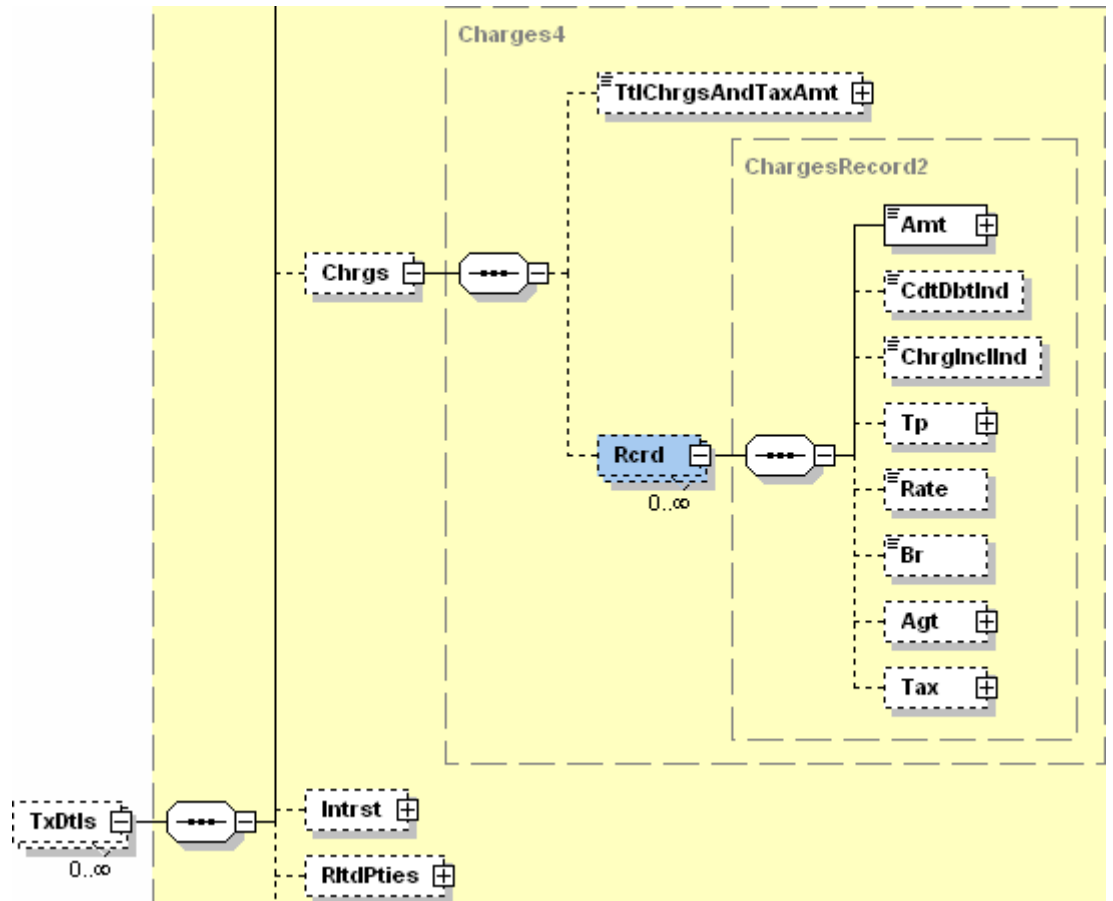

This section is mainly used with ISR credits where Batchbooking=TRUE for:

- ISR Type 3: Prices for in-payments/follow-on processing of ISR+
- ISR Type 4: Charges

---

## 4 Customer Credit Transfer Initiation

---

### 4.1 Principles of message structure

---

#### 4.1.1 Treatment of B- and C-Level in Customer Credit Transfer

---

Within messages (A-Level, document) B- and C-Level are interpreted as follows in Customer Credit Transfer:

B-Level: Payment Level – details of the ordering party (debtor, DEB) and instructions to the financial institution carrying out the transaction

C-Level: Transaction Level – details for the creditor (creditor, CR) and instructions to the receiving financial institution

#### 4.1.2 Inheritance of instructions

---

All instructions that are defined at B-Level automatically apply also to all associated C-levels. Elements which are permitted on more than one level can only be defined on one level (i.e. either at B- or C-Level). This is in line with the ISO 20022 rule.

Example: Element Category Purpose <CtgyPurp>: If the instruction SALA exists at B-Level, then **all** C-Levels are automatically also interpreted as SALA.

Further application information can also be found in section 4.5 "Instructions (Payment Instruments)".

#### 4.1.3 Elements which have no relevance to the Swiss recommendations

---

Elements which are not described in the Business Rules and Implementation Guidelines for the Swiss recommendations must not be used without consulting the financial institution (using such elements will lead to the whole message being rejected at the schema validation stage). In certain cases, an AOS (Additional Optional Service) can be agreed with financial institutions for a specific element, which is only processed within that financial institution.

## 4.2 Grouping of payments

Within a message (a Credit Transfer Initiation), payments can be grouped according to various criteria. All those payments (C-Level) can be grouped in a Payment Information (B-Level) which have certain common features, e.g. the same date of execution (Requested Execution Date).

### 4.2.1 Survey

Essentially there are three possible ways in which payments at B-Level could be grouped. In addition to the rules under the ISO standard, some of the conditions in these Business Rules and the Implementation Guidelines also affect the structuring of B- and C-Level. These are described below.

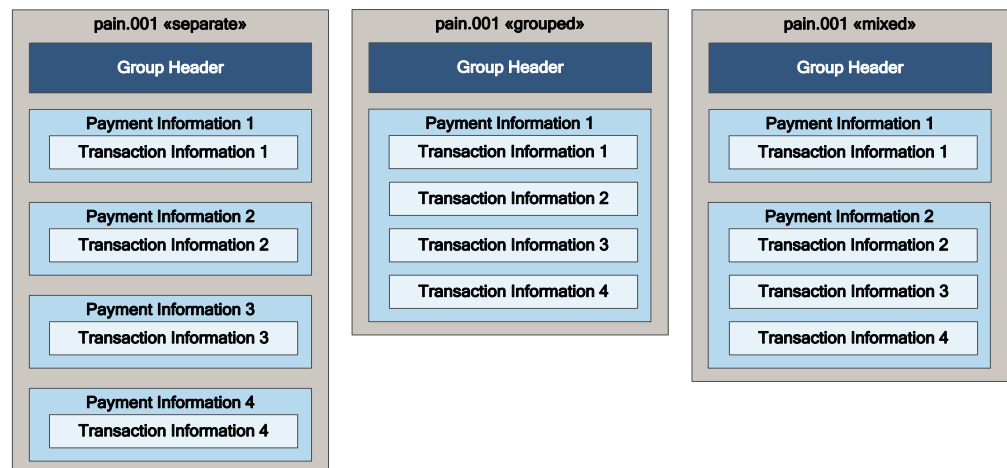

Figure 7: Grouping versions ("separate", "grouped", "mixed")

Version	Description
separate	Each B-Level contains exactly one C-Level. In this version, the elements at B-Level are repeated for every C-Level, even if they are identical. This structure generally has the effect that all payments are executed and booked separately.
grouped	The message contains only a single B-Level. All the elements that can be delivered at B-Level are only used once per message, so this is the version that takes up the least space. However, it presupposes that the information in the "Payment Type Information", "Ultimate Debtor" and "Charge Bearer" elements is the same for all payments.
mixed	More than one B-Level is used with one or more C-Levels. This structure allows for collective booking of separate C-Levels for each B-Level (one booking per B-Level). This is the most frequently used structure.

Table 12: Grouping versions ("separate", "grouped", "mixed")

---

## 4.2.2 Forming groups

---

Payments for which all elements of the B-Level are identical can be grouped together in one B-Level (for elements of the B-Level see section 3.2, or the Implementation Guidelines).

The following elements can be used either at B- or C-Level but not simultaneously at B- and C-Level. If these elements (including the sub-elements) are the same, they can be delivered at B-Level and the C-Levels grouped within that B-Level.

- Payment Type Information (for details see section 4.2.3)
- Ultimate Debtor
- Charge Bearer

## 4.2.3 Grouping based on "Payment Type Information"

---

The sub-elements "Instruction Priority" and "Category Purpose" are only taken into consideration when used at B-Level. Their use therefore always leads to a separate B-Level. If the two elements are the same in two C-Levels, they can be grouped into one B-Level, if the C-Levels allow this.

- Payment Type Information/Instruction Priority
- Payment Type Information/Category Purpose

Consequently, the following sub-elements must also be the same, because they must also be delivered at B-Level with the "Payment Type Information" component.

- Payment Type Information/Service Level
- Payment Type Information/Local Instrument

**Group forming rule:** For all payments (C-Level) in which "Instruction Priority" or "Category Purpose" needs to be used, a separate B-Level needs to be formed for each combination of "Instruction Priority", "Category Purpose", "Service Level" and "Local Instrument".



### 4.3 Booking information (Batch Booking)

If there is more than one transaction (C-Level), the Batch Booking element <BtchBookg> can be used for each B-Level to group the bookings as a batch booking. **The option TRUE is recommended.**

#### 4.3.1 Use of Batch Booking in Switzerland

The Batch Booking element <BtchBookg> controls the level at which the booking is carried out by the financial institution, for each B-Level:

- **TRUE:** As far as possible, one batch booking is made for each Payment Information (B). For each B-Level, the currency and the Charging Option and Instruction Priority elements must be the same.

☒	Additional Optional Service	Explanation
AOS	Batch Booking <BtchBookg>	Some financial institutions allow mixed currencies within the same B-Level. Mixed B-Levels are grouped by the financial institution according to currency and possibly also other criteria (e.g. charging options or instruction priority).

- **FALSE:** One separate booking is made per Credit Transfer Transaction Information (C).

If the element is not sent, the booking is handled as if it were TRUE.

For further information see section 4.7 "Controlling the debit advice (Debtor Account Type)".

**FALSE** produces a separate booking for each Transaction Information (C):

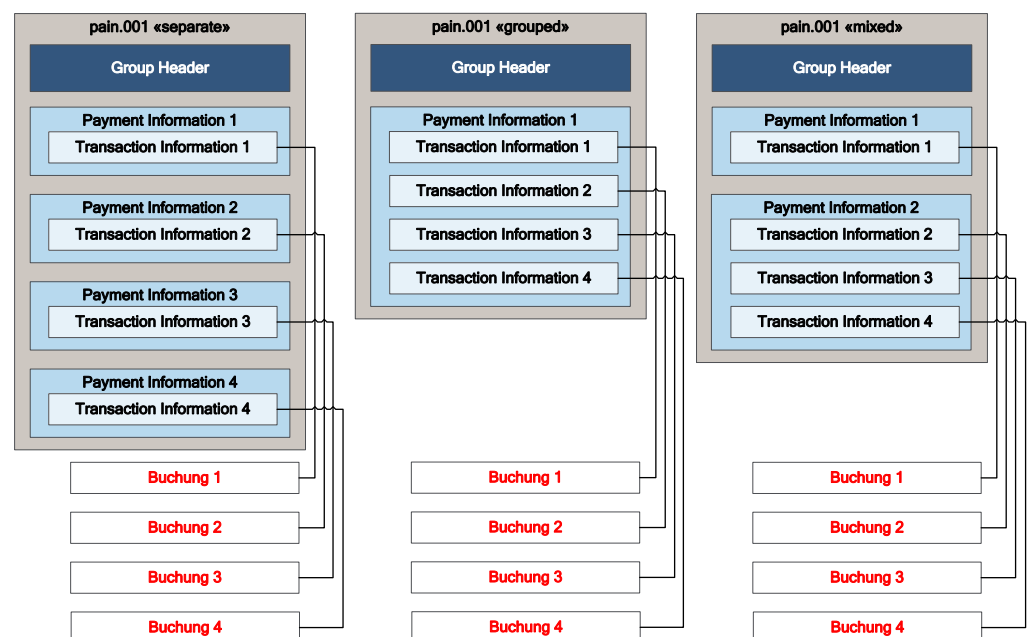

Figure 8: Batch Booking "FALSE"

**TRUE** produces a batch booking for each B-Level, wherever possible (provided that the currency, charging options etc. are the same. If one Payment Information (B) contains, for example, Credit Transfer Information (C) with two different currencies, then normally two batch bookings are created.):

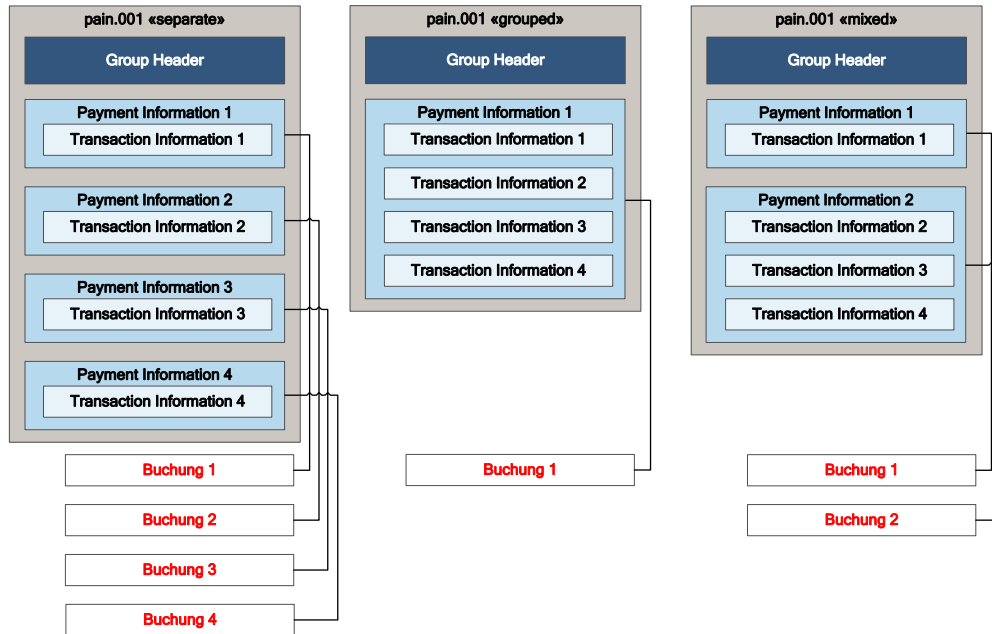

Figure 9: Batch Booking "TRUE"

The messages are validated accordingly and rejected if there are errors.

**Comment:** The information in the Batch Booking element is not an "order", but a request/enquiry from the customer to the financial institution, with which the financial institution will comply as far as possible. Implicitly, using this element also affects other notifications, e.g. in the form of paper or electronic account statements.

If a B-Level contains different currencies, then this can mean that, in accordance with "Best Effort", the B-Level is split into different orders (one order per currency). This may have the consequence that more than one "pain.002" is generated with the same "Payment Information Identification". This prevents automatic status comparisons. It is therefore recommended that one B-Level is created for each currency transferred.

#### 4.4 Customer Credit Transfer Initiation references

From the point of view of the customer (creator of the "pain.001"), the following references from the Customer Credit Transfer Initiation message "pain.001" for ISO notification messages (debit/credit "camt.054") and for ISO statement messages (camt.052/053) are relevant during reconciliation and for the Status Report (pain.002):

Level	ISO Index	Reference	ISO Definition Usage	Status	Description according to the Swiss recommendations	Use (when the reference is sent)		
						pain.002	camt.052/053/054	Interbank
A	1.1	<b>Message Identification</b>	Sent to the next party in the chain to unambiguously identify the message.	<b>M</b>	Most financial institutions check that this is unique for a period of at least 90 days. It is recommended that the "Message Identification" is normally kept unique for as long as possible.		Identifies the A-Level from the original message.	<b>Is not forwarded.</b>
B	2.1	<b>Payment Information Identification</b>	Identifies unambiguously the payment information group within the message.	<b>M</b>	This value must be unique within the whole message.	Identifies the B-Level from the original message.	Identifies the B-Level from the original message, corresponds to the customer's booking reference at B-Level.	<b>Is not forwarded.</b>
C	2.28 2.29	Payment Identification <b>+Instruction Identification</b>	Identifies unambiguously the instruction. Usage: the instruction identification is a point to point reference that can be used between the instructing party and the instructed party to refer to the individual instruction.	M <b>R</b>	Recommendation: should be used and kept unique within B-Level.	Identifies the C-Level (technical transaction reference). <b>Note for the recipient of the status message:</b> Without this reference, unambiguous attribution within the status message is more difficult.	Identifies the C-Level from the original message.	<b>Is not forwarded.</b>

Level	ISO Index	Reference	ISO Definition Usage	Status	Description according to the Swiss recommendations	Use (when the reference is sent)		
						pain.002	camt.052/053/054	Interbank
C	2.28	Payment Identification	Identifies unambiguously the transaction.	M	This is the reference from the original message, e.g. it may be the order number. The element is not intended for the ISR reference (no plausibility check takes place at this point).	Always sent back in the status report if there are errors/warnings at C-Level. If the End To End ID is not sent in the "pain.001" then the whole "pain.001" file is rejected with the remark "NOTPROVIDED" because of the schema violation.	Reference for the debtor from the original message; can be used for reconciliation purposes. Is only delivered if the transaction is booked separately or the recipient is receiving detailed information.	Is forwarded to the creditor.
	2.30	<b>+End To End Identification</b>	Usage: The end-to-end identification can be used for reconciliation or to link tasks relating to the transaction.	M				
C	2.98	<b>Remittance Information</b>	Information supplied to enable the matching of an entry with the items that the transfer is intended to settle, such as commercial invoices in an accounts' receivable system.	O	Purpose of the payment in structured or unstructured form.  <b>Structured:</b> For SEPA: "Creditor Reference" as per ISO 11649 For payment type ISR: ISR reference number (payment type 1 and E1)  <b>Unstructured:</b> e.g. notification text from the paying-in slip	<b>Is not sent.</b>	Is returned in the "camt" messages.  Is only delivered if the transaction is booked separately or the recipient is receiving detailed information.	Is forwarded to the creditor.

Table 13: Customer Credit Transfer Initiation references

### Variants in the case of Customer Direct Debit Initiation references

For the "End To End Identification" and "Remittance Information" elements, there are the following variants in connection with Swiss Direct Debit:

Level	ISO Index	Reference	ISO Definition Usage	Status	Description according to the Swiss recommendations	Use (when the reference is sent)		
						pain.002	camt.052/053/054	Interbank
C	2.28	Payment Identification	Identifies unambiguously the transaction.	M	This is the reference from the original message, e.g. it may be the order no. This element is not intended for the ISR reference, a plausibility check is carried out here for CH-DD.  <b>CH-DD:</b> For automated debtor accounting, the use of a unique End To End ID is strongly recommended.  <b>CH-DD/CH-TA:</b> If this is not available, the value "NOTPROVIDED" must be sent.	Always returned in the Status Report if there are errors/warnings at C-Level. If the End To End ID is not given in the "pain.008", then the whole "pain.008" file is rejected because of the schema violation.  <b>CH-DD/CH-TA:</b> If this is not available, the "pain.008" is rejected and the value "NOTPROVIDED" is forwarded.	Reference for the debtor from the original message; can be used for reconciliation purposes.  Is only delivered if the transaction is booked separately or the recipient is receiving detailed information.	Is forwarded to the debtor.
	2.30	<b>+End To End Identification</b>	Usage: The end-to-end identification can be used for reconciliation or to link tasks relating to the transaction.	M				

Level	ISO Index	Reference	ISO Definition Usage	Status	Description according to the Swiss recommendations	Use (when the reference is sent)		
						pain.002	camt.052/053/054	Interbank
C	2.98	<b>Remittance Information</b>	Information supplied to enable the matching of an entry with the items that the transfer is intended to settle, such as commercial invoices in an accounts' receivable system.	O	Purpose of the payment in structured or unstructured form.  <b>CH-DD:</b> May only be used in unstructured format.  <b>CH-TA:</b> Must be used in structured format and can also optionally be used unstructured.	<b>Is not sent.</b>	Is returned in the "camt" messages.  Is only delivered if the transaction is booked separately or the recipient is receiving detailed information.	Is forwarded to the debtor.

Table 14: Variants in the case of Customer Direct Debit Initiation references

**Comment** about the status column:

- M** Mandatory (either in the XML schema or according to the EPC Implementation Guideline for SEPA payments)
- R** Recommended (should be present in messages, according to the Swiss Implementation Guidelines)
- D** Dependent (must be present in messages, according to the Swiss Implementation Guidelines, depending on other elements or the payment method selected)
- BD** Bilaterally Determined (only permitted by agreement with the financial institution)
- O** Optional

For detailed information see Implementation Guidelines CT [14].

This results in the following use of references, with the End To End Identification <EndToEndId> and the Remittance Information <RmtInf> being passed on by the financial institutions (debtor's and creditor's institutions) all the way through to the creditor:

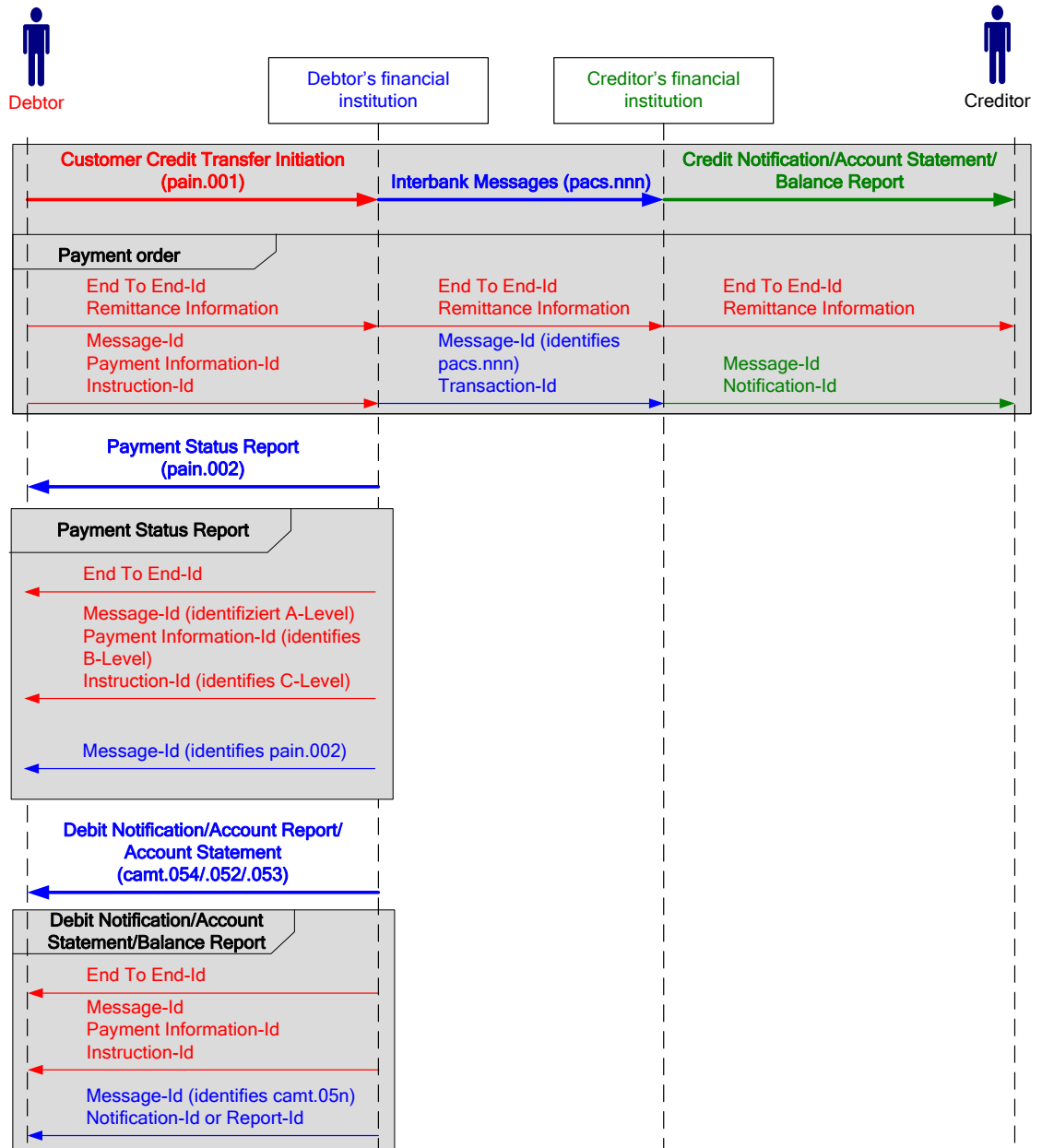

Key:  
 Elements marked in red are generated by the debtor.  
 Elements marked in blue are generated by the creditor's financial institution.  
 Elements marked in green are generated by the debtor's financial institution.

Figure 10: Customer Credit Transfer references

## 4.5 Instructions (Payment Instruments)

---

Different instructions are controlled by the Payment Method <PmtMtd> (B-Level), Payment Type Information <PmtTplnf> (B- or C-Level) and Cheque Instruction <ChqInstr> (C-Level) elements.

### 4.5.1 Overview

---

The instructions are defined in five elements.

#### 1. Element Payment Method (B-Level)

The Payment Method element (B-Level) distinguishes between three types of payment:

- **TRF**: Credit Transfer (Transfer of an amount of money in the books of the account servicer)
- **TRA**: Transfer Advice (Transfer of an amount of money in the books of the account servicer. An advice should be sent back to the account owner)
- **CHK**: Paper/Cheque (Written order to a bank to pay a certain amount of money from one person to another person)

More information can be given in the following elements under Payment Type Information (B- or C-Level):

#### 2. Element Instruction Priority (HIGH or NORMAL)

#### 3. Element Service Level (e.g. SEPA) or Clearing Channel

#### 4. Element Local Instrument

#### 5. Element Category Purpose

Acc. to ISO 20022 Ref. [1]: If Payment Type Information is used at Level B, then it cannot be used at Level C, i.e. the C-Level is rejected.

In the case of CHK, more information is given in elements under Cheque Instructions. The Local Instruments level can be used for other (national) required information.

### 4.5.2 Applying the instructions in Switzerland

---

All instructions defined at B-Level also apply automatically to all the associated C-Levels. Elements that are permitted at more than one level can only be defined on one level (i.e. either on B- or C-Level). This corresponds to the ISO 20022 rule.

Example: Category Purpose <CtgyPurp> element: If the instruction "SALA" is delivered at B-Level, then **all** C-Levels are automatically also interpreted as "SALA".



#### 4.5.2.1 Using the Payment Method element

The value TRA is processed in Switzerland in the same way as TRF and has no special function (see also 4.7 "Controlling the debit advice (Debtor Account Type)"). Both values are permitted, but TRF is recommended.

Otherwise, for cheque payments and payment notifications (postal mandates), the value CHK is required.

#### 4.5.2.2 Using the Payment Type Information element – survey

The structured Payment Type Information element <PaymentTypeInfo1> with its optional sub-elements can occur both at B-Level and at C-Level (although generally either the B- or C-Level can be filled in, not both). The following table shows how Swiss financial institutions proceed with validating this element.

Element	B-Level	OR	C-Level
Instruction Priority <InstrPrty>	✓		–
Service Level <SvcLvl>	✓		✓
Local Instrument <LclInstrm>	✓		✓
Category Purpose <CtgyPurp>	✓		–

The Purpose can only occur at C-Level:

Element	B-Level	OR	C-Level
Purpose <Purp>	x		✓

"✓" = may occur, "–" = is ignored, "x" = must not occur

#### 4.5.2.3 Using the Payment Type Information element – Instruction Priority

According to ISO 20022, this element defines the urgency of processing at the debtor's financial institution. It is not an instruction indicating the priority of booking or execution of the payment process at the financial institution.

Element	Explanation
Instruction Priority <InstrPrty>	<p>The value "NORMAL" indicates processing with the value date as the next banking day or on the "Requested Execution Date" as sent (depending on the currency).</p> <p>The value "HIGH" indicates processing on the same value date, provided the instruction is delivered within the acceptance period specified by the financial institution in question (depending on the currency). This kind of processing may incur additional charges. The value "HIGH" generally equates to the Express flag in today's online solutions.</p>

#### 4.5.2.4 Using the Payment Type Information element – Service Level/Clearing Channel

---

According to ISO 20022, this element describes an agreement or rule about how an order should be executed. It can be either a defined Service Level or a proprietary Text Code. The Service Level affects the payment process at the financial institution.

##### **Service Level element**

The following values are supported by Swiss financial institutions:

- Code <Cd>: **SEPA** (value from ExternalServiceLevel1Code list, according to the current SEPA-SL, from 1.1.2012 ≤ 1 day for a guaranteed credit).

**Comment:** If SEPA is used in the Service Level Code element, then the order is validated by the financial institution according to the SEPA procedure.

If the element is not sent, yet the order does meet SEPA criteria, it can be handled under "Best Effort" as a SEPA transaction by the financial institutions (a processing decision by the financial institution in question).

There are various other values in the external code list, and of these the following are accepted by the financial institutions:

- **PRPT** (EBA Priority Service)
- **SDVA** (Same Day Value)
- **URGP** (Urgent Payment)

These values, "SEPA", "PRPT", "SDVA", "URGP" are taken into account provided that the financial institution offers that service, otherwise they are ignored (not forwarded, but the order is not rejected).

All other codes and "Proprietary" are only supported by agreement with the financial institution. If this is not the case, the value that is sent is ignored, not forwarded, but the order is not rejected.

Support for other values from the external codes list must be agreed with the financial institution. If the financial institution does not offer the service in question, they are ignored (not forwarded, but the order is not rejected).

#### 4.5.2.5 Using the Payment Type Information element – Local Instrument

---

On payment orders, the element is used to identify payment types (for details see Implementation Guidelines CT [14]).

This element is used in association with the SEPA Direct Debit Procedure to distinguish between CORE and B2B.

#### 4.5.2.6 Using the Payment Type Information element – Category Purpose/Purpose

---

##### Category Purpose element

In the Category Purpose element, codes from an external ISO 20022 code list (type ExternalCategoryPurposeCode, see [www.iso20022.org](http://www.iso20022.org)) can be used to give information about the purpose of a payment order (B-Level, debit side). For example, the following codes are possible: SALA, PENS, DIVI, TAXS, INTC.

In the Swiss recommendation, the element has only an effect for salary payments marked as SALA or for pension payments marked as PENS (see section 4.11 "Salary/pension flag (Element Category Purpose <CtgyPurp>").

##### Purpose <Purp>

Like the Category Purpose <CtgyPurp>, predefined codes from an external ISO 20022 code list (type ExternalPurposeCode, see [www.iso20022.org](http://www.iso20022.org)) are used to identify the payment (C-Level, creditor side). The element is passed on by the institutions when the payment is made.

**Comment:** If the instruction is to apply to the credit and debit sides, then both elements must be sent: at B-Level "Category Purpose" and at C-Level "Purpose".

**Comment:** The financial institutions do not carry out any checks for consistency between the two elements.

**Example:** The combination "Category Purpose = SALA" and "Purpose = PENS" is not recommended, but would be accepted.

#### 4.6 Identification of the parties involved

---

There follows a description of the main features for identifying the parties involved. Different elements are used, depending on the payment type (see also tables in section 2 "Business situations").

##### 4.6.1 Identification of financial institutions

---

Refers to the Debtor Agent (B-Level) and Creditor Agent elements (C-Level, Financial Institution Identification).

##### 4.6.1.1 Debtor Agent (<DbtrAgt>) and Creditor Agent (<CdtrAgt>)

---

Swiss financial institutions recommend using the identification instead of the name/address of the financial institution wherever possible for national and international payments. For this, the Business Identifier Code (BIC) and the institutional identification (IID) are available. For international payments the use of BIC is recommended, for national payments the use of the IID.

The following ISO 20022 elements are available

- <BIC> or
- <ClrSysMblD>/<MmblD> and <ClrSysMblD>/<ClrSysId>/<Cd>

When entering the clearing number, the clearing number of the financial institution is entered in the <ClrSysMblD>/<MmblD> element, and in the <ClrSysMblD>/<ClrSysId>/<Cd> element, the code CHBCC determines that there is a Swiss bank clearing number in the <MmblD> element. Entering the 6-digit SIC number (CHSIC) is not permitted in customer messages.

If the identification of the financial institution is not known at the Creditor Agent, the following two elements can be used:

1. <Nm>
2. <PstlAdr>

#### 4.6.1.2 Forwarding Agent and Intermediary

---

Both elements are AOS (see 3.1 "Summary of message flow").

In general, the definitions given above also apply to identifying a financial institution in these elements.

#### 4.6.2 Identification of debtor and creditor

---

The debtor, (B-Level) and the creditor (C-Level) should be identified with their name and address (Customer Identification) and account number (Account Identification).

##### 4.6.2.1 Name and address of debtor and creditor

---

###### Debtor

Swiss financial institutions recommend using the <Nm> (Name) element here.

**Comment:** The debtor is only identified using the Debtor Account element. Information in the Debtor field is ignored. What counts is the master data held by the financial institution for this debtor.

###### Creditor

In Switzerland, use of the <Nm> (Name) element is mandatory.

In addition, all other available information about the creditor can also be sent:

- Address <PstlAdr>  
(address, if possible structured (e.g. Street Name, Building Number), otherwise unstructured in the <AdrLine> element with max. 2 lines, but not both)
- Identification <Id>
- Country <CtryOfRes>

In the case of ISR this element is not required. If it is filled in, it is ignored by the financial institutions.

In the case of a bank cheque or payment instruction, the complete address must be filled in with the name/company name, postcode and town (if possible also the street name).

**4.6.2.2 Account number of debtor and creditor**

---

**Account number of debtor (Debtor Account)**

For this element, Swiss financial institutions recommend using

- <IBAN> or
- <Othr>/<Id> (postal account number or bank account number of the financial institution in question)

**Account number of creditor (Creditor Account)**

For this element, Swiss financial institutions recommend using

- <IBAN> (for IBAN countries) or
- <PrtryAcct> (postal account number or bank account number of the financial institution in question, in the case of ISR the ISR participant number)

**Comment:** For cheques and payment instructions the Creditor Account element is not used.

**Comment:** IBAN becomes mandatory: The exclusive use of IBAN in Switzerland will apply from 2020. In the meantime, the Swiss banks are helping their corporate clients to switch to the international standard.

**4.6.3 Identification of "Ultimate" Debtor and Creditor**

---

This information is generally structured and defined in the same way as defined for the creditor and debtor (see above).

## 4.7 Controlling the debit advice (Debtor Account Type)

The type of debit advice (camt.054) can be selected in the message. This selection can override what is defined in the master data of the financial institution. The following notification options can be entered:

- Single booking
  - no advice
  - single advice
- Collective booking
  - no advice (bookings are only listed in the account statement)
  - collective advice with no details
  - collective advice with details

All the financial institutions offer these options, but the precise definition may vary for each institution.

This information in the message refers to the data content of the debit advice and does not control on which advice and whether it is sent on paper or electronically, or the details of the layout of the advice.

The type of advice is selected using the Payment Information/Batch Booking and Payment Information/Debtor Account/Type/Prtry elements (the Payment Method element is not used in this context).

Type of debit advice	Payment Information		
	Batch Booking	Debtor Account/ Type/ Prtry	Payment Method
<b>Single booking</b>			
No advice	FALSE	NOA	TRF/TRA/CHK
Single advice	FALSE	SIA	TRF/TRA/CHK
<b>Collective booking</b>			
No advice	TRUE	NOA	TRF/TRA/CHK
Collective advice with no details	TRUE	CND	TRF/TRA/CHK
Collective advice with details	TRUE	CWD	TRF/TRA/CHK

Table 15: Controlling the debit advice

**Comment:** Both the Payment Information/Batch Booking and Payment Information/ Debtor Account/Type/Prtry elements are used at B-Level. The Payment Information/Payment Method element is not used to control the advice but is used to distinguish between transfers with or without a financial institution on the creditor side.

Meaning of the codes in the Debtor Account/Type/Prtry <Prtry> element:

- NOA No Advice
- SIA Single Advice
- CND Collective Advice No Details
- CWD Collective Advice With Details

If this element is not present, the debit advice is sent according to the master data of the financial institution (according to ISO 20022 Customer-to-Bank Message Usage Guide Customer Credit Transfer Initiation: "provided this type of service is pre-agreed between the debtor and its bank").

Any other combinations, e.g. Batch Booking = TRUE and Debtor Account/ Type/Prtry = SIA will be rejected (also invalid codes not included in the external code list).

Meaning of the codes in the Payment Method <PmtMtd> element:

- TRF Credit Transfer
- CHK Cheque
- TRA Transfer Advice

The value TRA is processed in Switzerland in the same way as TRF and has no special function. The values TRF, TRA and CHK have no effect on whether a debit advice is created or not. Similarly for account statements, the definitions in the master data held by the financial institution apply. These cannot be overridden in the message.

## 4.8 Limiting the message size

---

There is no limit on the message size (max. number of transaction records). Depending on the financial institution, a message may be split during processing for technical reasons, and in some circumstances this may affect the number of bookings.

**Recommendation:** At present, customers are recommended not to send messages (files) to their financial institution that exceed 99,999 payments (C-Level, transactions).

## 4.9 Character set

---

In principle, ISO 20022 XML messages support the UTF-8 character set. Of that, only the "Latin Character Set" is permitted by Swiss financial institutions and in the SEPA area, and this is the one already in use. The exact list of permitted characters and a conversion table can be found in the Swiss Implementation Guidelines.

## 4.10 Checking for duplicates

At Swiss financial institutions, checking for duplicates at least takes place at the level of the document (message). This is why the contents of the Message Identification element <MsgId> must be unique, so as to serve as the criterion for preventing duplicate processing of files which have accidentally been submitted twice. At most financial institutions, the uniqueness is maintained for a period of at least 90 days.

For software providers, this means that they must be able to identify their messages uniquely using Message Identification for at least 90 days. Messages with the same Message Identification will be rejected.

It is recommended that the Message Identification remains unique for as long as possible, to make any subsequent investigations easier.

**Comment:** Usually, financial institutions also implement other technical duplicate checking of other elements (A-, B- or C-Level).

## 4.11 Salary/pension flag (Element Category Purpose <CtgyPurp>)

At present, Swiss formats for electronic payment transactions recognise a "Salary Flag" or "Pension Flag", which, for example in DTA format, may be specially inserted in the header for transaction types 827, 836 and 837 (DTA field designation Payment Type = 1).

If this flag is inserted by the debtor, this currently has implications for the processing and notification of payment orders (separate grouping, suppression of details, etc.).

### 4.11.1 Controlling the notification

#### Debit side

In ISO 20022, the equivalent of the salary flag is the Category Purpose element with the code **SALA** (salary) or **PENS** (pension). Unlike with the DTA standard, these codes (e.g. SALA for salary) have no effect on the **type of processing and notification**, because sufficient and explicit options for controlling notification (see also 4.7 "Controlling the debit advice (Debtor Account Type)") are already available. Thus, the Debtor Account Type element controls the required notification type and the Category Purpose element is passed on for information by the various financial institutions during further processing.

☒	Additional Optional Service	Explanation
AOS	Overriding the advice type	For the "SALA" and/or "PENS" codes, some financial institutions override the advice type, as described in section 4.7 "Controlling the debit advice (Debtor Account Type)" in the account advice or detailed notification. However, all institutions ensure that the transaction amounts are not shown for the "SALA" code.



**Online banking displays** are not affected in principle, although the SALA code can be used (in the Category Purpose element at B-Level) to control access authorisation in the case of approvals and authority to sign, where this is defined at B-Level. If the Category Purpose was defined at C-Level, this has no effect on the display.

### Credit side

The corresponding element in ISO 20022 is Purpose <Purp> (C-Level). In interbank traffic, this element is passed to the creditor's financial institution and contains no control instructions (e.g. for credit advice). In the case of salary or pension payments, the Purpose codes SALA and PENS are available for use here.

**Comment:** If the salary identifier is to apply to both the credit and debit side, then both elements must be sent: at B-Level **Category Purpose** and at C-Level **Purpose**.

If a customer (software provider) requires the same behaviour on the debit side as today, the following elements must now be correctly submitted:

- **Category Purpose** = **SALA or PENS**  
Recommendation: always B-Level
- **Debtor Account/Type/Prtry** = **NOA** or **CND** (only for collective payments)
- **Batch Booking** = **TRUE** (B-Level)

It is recommended that a separate message (message/document) is created for salary or pension payments.

**Comment:** If, contrary to the above suggestions, the Category Purpose is entered in the specific C-Levels, then some C-Levels could contain SALA and others different or no values. In this case, where BatchBooking = **TRUE**, the customer would receive **no** separate bookings for SALA (BatchBooking = **TRUE** corresponds to one debit with one booking, but this is **not** identified as "salary").

## 4.12 Version for cheques and payment instructions (postal mandate)

---

For cheques and payment instructions (instructions with no account number on the creditor side), the following definitions apply (see also section 2 "Business situations"):

- Element Payment Method: must contain CHK
- Element Creditor Agent: is not sent
- Element Creditor: must contain the full address or a unique identifier for the creditor (address including name, postcode, town and street and house number if available).
- Element Cheque Instruction: contains sub-elements for cheque-specific instructions.

**Comment:** Cheques are always sent in a separate B-Level (see also 4.5.2.1 "Using the Payment Method element") (because the Payment Method element is defined at B-Level). Under ISO 20022, stating the creditor's account number in combination with CHK is not allowed.

**Note:** It is up to the financial institutions to decide whether they offer the payment type Check. The actual range of payment types that are offered is described in institute-specific service descriptions.

## 4.13 Definitions of specific elements

---

### 4.13.1 Requested Execution Date element

---

The <ReqdExctnDt> element (mandatory) contains the requested date of execution (date on which the account should be debited – value date) for the payment order. For the financial institutions, the same rules apply as before:

- If a date in the past is entered: automatic correction to the next possible date of execution (banking day, Post Office working day)
- Valid date range for banks:
  - Date of execution no more than 60 calendar days in the future (from submission date)
  - Date of execution no more than 10 calendar days in the past (from submission date)
- Valid date range for PostFinance:
  - $-90 \leq \text{date of execution} < 720$  days  
(for orders with fewer than 1000 items)
  - $-90 \leq \text{date of execution} < 90$  days  
(for orders with more than 1000 positions)

**Comment:** On account of, for example, acceptance time limits at a particular financial institution, the date of execution <ReqdExctnDt> may be postponed to the next possible working day. Financial institutions generally may have different acceptance times depending on the channel and type of payment.

### 4.13.2 Instruction for Debtor Agent and Creditor Agent element

---

These elements can only be used for instructions which are not already included in other elements of the standard (e.g. urgent payments should be ordered setting the Instruction Priority element as HIGH or NORMAL).

**Comment:** The use of instructions can lead to delays and additional processing costs.

Element	Explanation
Instruction for Debtor/Creditor Agent	Depending on the agreement with the financial institution, instructions may be used.

<input checked="" type="checkbox"/>	Additional Optional Service	Explanation
AOS	Use of "Instruction for Debtor/Creditor Agent" for payment types 1, 2.1, 2.2, 3, 5	For payment types ISR, IS, inland CHF & EUR transfer and SEPA, the element may only be used as an AOS by agreement with the financial institution.



**4.13.3 Control Sum**

---

Swiss financial institutions recommend always using this field <CtrlSum> at A-Level (sum of individual transactions, regardless of currency). If there is an entry in the field, it is validated by the financial institution.

## **5 Customer Direct Debit Initiation**

---

### **5.1 Handling B- and C-Levels in Direct Debit**

---

The A-, B- and C-Levels in Direct Debit are interpreted in the same way as in Customer Credit Transfer, but with the roles of Debtor and Creditor reversed (B-Level equates to Creditor and C-Level to Debtor). The definitions of the elements in Section 4 "Customer Credit Transfer Initiation" also apply to Direct Debit. The specific details for processing the Customer Direct Debit Initiation message (pain.008) are described in the Implementation Guidelines

- for the Swiss direct debit procedure and
- for the SEPA direct debit procedure

Currently in Switzerland, the SEPA Core Direct Debit and the SEPA B2B Direct Debit is supported. The national direct debit procedure remains in place for the time being, separately from SEPA Direct Debit.

The ISO 20022 Maintenance Release 2009 (pain.008.001.02 and pain.002.001.03) is supported in accordance with the current EPC recommendations for the SEPA direct debit procedure.

In the same way as for a payment order, the financial institutions usually provide a Status Report in "pain.002" format for each message that is submitted.

## 6 Customer Payment Status Report (pain.002)

When a "Customer Transfer Initiation" or "Customer Direct Debit Initiation" is delivered, it is always responded to with at least a Payment Status Report.

The status message is a direct, instant response from the financial institution to the receipt of a "Customer Credit Transfer Initiation" or "Customer Direct Debit Initiation" message. The status message may be a response to the whole message or just to certain specific B-Levels within the message. It is not a confirmation of processing by the financial institution.

The "Customer Payment Status Report" (pain.002) is described in detail in the relevant Implementation Guideline. This Guideline also contains the following Additional Optional Services (AOS) for the Status Report.

☒	Additional Optional Service	Explanation
AOS	Recipient of the Status Report different from the sender	The "Payment Status Report" generally goes to the sender of the "Customer Credit Transfer". That may also be the "Initiation Party". The "pain.002" message can also go to the debtor if they are not the sender of the "pain.001" (e.g. for status reports in the case of a change of status for the order due to approvals, deletions, execution etc.)

☒	Additional Optional Service	Explanation
AOS	Statuses in "pain.002" status reports	As well as the statuses described above, which are supported by all Swiss financial institutions, other optional statuses are possible at certain institutions. These are: <ul style="list-style-type: none"> <li>• PDNG (Pending) Status: Group, PmtInf</li> <li>• ACSP (Accepted for Clearing) Status: Group, PmtInf</li> </ul>

☒	Additional Optional Service	Explanation
AOS	Additional status reports	Other changes in the status of the order, e.g. because of approvals, deletions, execution etc. may be reported back in additional status reports, depending on the financial institution.

## **7 General statement on the introduction**

---

### **7.1 Transitional scenarios**

---

#### **Bank – Bank**

Until ISO 20022 is fully implemented in interbank business (SIC, SWIFT), there are limitations on the scope of the data that can be transmitted. This means that data elements from the ISO standard which cannot be directly reflected in existing formats cannot be passed on, or only with limitations.

#### **Bank – Customer**

The same limitations apply to data exchanges with customers, until the "camt" messages are introduced across the board by the financial institutions for notifications and account statements. The ISO 20022 reporting section will only be able to be supported on the debtor side when "camt" messages have been fully introduced.

### **7.2 Date of introduction for financial institutions**

---

Initial options for delivery are already available today. You should always check directly with the financial institution in question about the exact scope of the messages they can handle and the date of introduction (see also [www.iso-payments.ch](http://www.iso-payments.ch) for the dates published by financial institutions and software producers).

Deadline: decision by SPC (Swiss Payments Council) still awaited.

## 8 Central validation point

The migration of customers, software providers and financial institutions is supported by a central validation portal for customer-bank messages. The aims of this validation portal are:

- to encourage consistent use of the ISO 20022 standard, especially the Swiss Business Rules and Implementation Guidelines, by all financial institutions and software providers
- to avoid errors and problems in delivering and receiving ISO messages between customers or software providers and financial institutions
- to provide a central upstream validation point as the basis for any additional bilateral tests between banks and customers or software providers (at present each financial institution has to carry out bilateral tests with each software provider)
- to coordinate and further develop the Implementation Guidelines with the PaCoS working group 20022 Payments CH.

All messages for which Implementation Guidelines have been published are supported by the validation portal:

- pain.001: Customer Credit Transfer Initiation
- pain.008: Customer Direct Debit Initiation for the Swiss direct debit procedure
- pain.008: Customer Direct Debit Initiation for the SEPA direct debit procedure
- pain.002: Payment Status Report
- camt.052: Bank to Customer Report
- camt.053: Bank to Customer Statement
- camt.054: Bank to Customer Debit/Credit Notification

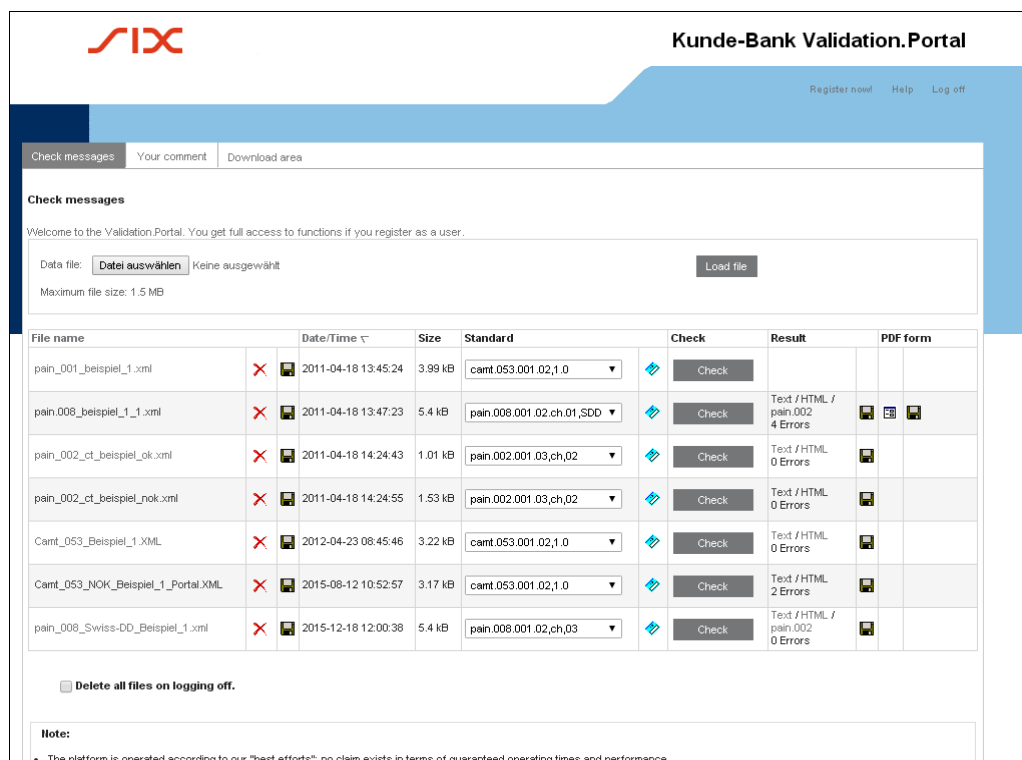

File name	Date/Time	Size	Standard	Check	Result	PDF form
pain_001_beispiel_1.xml	2011-04-18 13:45:24	3.99 kB	camt.053.001.02,1.0	Check		
pain_008_beispiel_1_1.xml	2011-04-18 13:47:23	5.4 kB	pain.008.001.02.ch.01_SDD	Check	Text / HTML / pain.002 4 Errors	
pain_002_ct_beispiel_ok.xml	2011-04-18 14:24:43	1.01 kB	pain.002.001.03.ch.02	Check	Text / HTML 0 Errors	
pain_002_ct_beispiel_nok.xml	2011-04-18 14:24:55	1.53 kB	pain.002.001.03.ch.02	Check	Text / HTML 0 Errors	
Camt_053_Beispiel_1.XML	2012-04-23 08:45:46	3.22 kB	camt.053.001.02,1.0	Check	Text / HTML 0 Errors	
Camt_053_NOK_Beispiel_1_Portal.XML	2015-08-12 10:52:57	3.17 kB	camt.053.001.02,1.0	Check	Text / HTML 2 Errors	
pain_008_Swiss-DD_Beispiel_1.xml	2015-12-18 12:00:38	5.4 kB	pain.008.001.02.ch.03	Check	Text / HTML / pain.002 0 Errors	

Delete all files on logging off.

**Note:**

• The platform is operated according to our "best efforts", no claim exists in terms of guaranteed operating times and performance.

Figure 11: Validation portal customer-bank



The scope of the validation portal is as follows:

- Customers, software providers and financial institutions can upload created messages to the validation portal via the Web.
- The validation results are made available for customers, software providers and financial institutions to view and download in the form of a "pain.002" message and a description of the generated test results (text and HTML).
- In the description that is generated showing the validation results, a distinction is made between "Errors" and "Notes". Whereas messages containing "Errors" will generally be rejected by the financial institution, "Notes" are intended to draw attention to possible discrepancies in the validated message from the recommendations in the Implementation Guidelines. "Notes" should not lead to a message being rejected.
- SIX Interbank Clearing will make points of contact available to run the platform and will raise any problems that arise with the working groups of the financial institutions so that the Swiss recommendations can be clarified and supplemented.

**Comment:** Before the first delivery of an ISO message to a financial institution, the software provider/customer must contact the relevant financial institution and explain how to use the various ISO messages. A positive result from the validation platform does not replace any more far-reaching institution-specific tests which may be required.

## 9 Business Rules Customer Cash Management

### 9.1 "camt" messages – the future of electronic account information

In order to comply with national and international regulatory requirements and achieve end-to-end automated processing of transactions, the Swiss financial services industry will in future use "camt" messages in accordance with the globally recognised ISO 20022 standard for electronic account statements.

When a customer is converted to the ISO 20022 message standard, it is recommended that, wherever appropriate, the customer also receives the new "camt" messages in place of existing SWIFT messages and other electronic reports such as the ISR file "V11". The additional information in "camt" enables synergies in the value chain between payment transfer providers, financial institutions and consumers to be exploited more efficiently and data truncation avoided.

However, the switch to "camt" is also necessary in order to comply with national and international regulatory requirements such as the Federal Act on Combating Money Laundering and Terrorist Financing (GwG), since "camt" messages are able to carry the required additional information end-to-end.

It is expected that the new paying-in slip with data code (ES with data code) or with data code and reference number (ISR with data code) will be introduced from 2018. The implementation of regulatory requirements obliges financial institutions to offer "camt" messages for the electronic notification of incoming payments based on the new procedure.

### 9.2 Messages according to the Swiss recommendations

Cash Management messages are used for the purpose of reporting to customers as both debtors and creditors.

In this context, the "pain.002" message (Payment Status Report) at the customer interface is not regarded as Cash Management message, since this message is only created in relation to specific orders.

Cash Management messages are used for reporting. Swiss financial institutions can offer the following message types:

ISO 20022 message	Application	SWIFT MT
camt.052	Bank to Customer Account Report (intra-day account transactions)	MT942, MT941
camt.053	Bank to Customer Statement (end-of-day account statement)	MT940, MT950
camt.054	Bank to Customer Debit/Credit Notification (debit/credit notification)	MT900, MT910

Table 16: Cash Management messages

Optional messages	Explanation
Support for camt.052	Not all financial institutions offer messages for displaying intraday account movements.
Support for camt.054	Not all financial institutions offer messages for displaying debits/credits.

Table 17: *Optional Cash Management messages*

## 9.3 Principles of message structure

---

### 9.3.1 Handling B-, C- and D-Levels

---

B-, C- and D-Levels within messages (A-Level, Document) are interpreted in Customer Cash Management as follows:

- B-Level: Account level (Statement) – details in the statement (report) relating to the account, e.g. account number, currency and balance.
- C-Level: Amount level (Entry) – details about a booking, e.g. date, credit/debit, total amount and currency. The C-Level can be repeated and may be absent if there are no bookings.
- D-Level: Amount details (Entry Details) – detailed information about a booking e.g. references sent previously by "pain.001" of the debtor (e.g. End To End Identification) and reference of the creditor (Remittance Information, e.g. ISR reference or Creditor Reference). The Swiss Business Rules envisage that a D-Level will be displayed for each C-Level. It is expected that detailed information about a booking will be filled in at D-Level.

## 9.4 Different versions of camt.052, camt.053 and camt.054

---

Depending on the message, significant information either has to appear in the statement, may appear or is not filled in. The following summary shows the main differences:

Information/Message	camt.052 Account Report	camt.053 Statement	camt.054 Debit/Credit Notification
<b>Header (A-Level)</b>	must	must	must
<b>Account (Statement: B-Level)</b>	must <sup>2</sup>	must	must <sup>3</sup>
<b>Booking (Entry: C-Level)</b>	optional	optional	must
<b>Booking details (Entry details: D-Level)</b>	optional	optional	must
Booked booking	✓	✓	✓
Provisional booking	✓	–	✓
Booking details	✓	✓	✓

"✓" = Attribute can occur / "–" = Attribute does not occur

Table 18: Versions of Cash Management messages

### Definitions:

**Booked booking:** This is a **definite booking** (generally the result of day-end processing), which can no longer be deleted. It can only be corrected by a booking cancellation which is visible to the customer.

**Provisional booking:** An **intra-day booking** becomes a booked booking at the end of the day (see above). Where a booking is the result of intra-day processing, it can also only be corrected by a booking cancellation which is visible to the customer.

## 9.5 Size restriction

---

Any size restrictions on "camt" messages should be agreed with the institution in question.

## 9.6 Referencing certain messages

---

The "Message Identification" element in the "Group Header" group of elements is used to reference a "camt.05x" message. This reference is institute-specific and unique for at least one year.

---

<sup>2</sup> Balance optional

<sup>3</sup> No balance

## 9.7 Breakdown of batch bookings (pain.001, pain.008)

---

### 9.7.1 Batch booking scenarios

---

Various batch booking scenarios are supported by the Swiss recommendations. A useful distinction to make is between "Grouped by the customer" and "Grouped by the financial institution":

- **Grouped by the customer:** The customer plays the active role. He groups transactions in transfer messages (pain.001) or collects SEPA direct debits (pain.008) by using the Batch Booking Indicator.
- **Grouped by the financial institution:** The bank plays the active role. It groups transactions on behalf of the customer or for the customer, for example in the case of incoming ISRs or incoming Swiss direct debits..

A batch booking breakdown is normally offered by financial institutions mainly when the financial institution does the grouping, because the customer in this scenario urgently needs the batch booking breakdown for their account reconciliation. In scenarios where the customer does the grouping, the customer himself already has all the details in their own system and therefore requires little further information. For that reason, in this case there is often no need for a batch booking breakdown.

Which transactions are grouped by a financial institution, and how, is specific to each institution and varies from one financial institution to another.

### 9.7.2 Possible batch booking breakdown

---

Batch bookings can be broken down in two ways

- **Internally:** Batch booking breakdown within one "camt.053" message (account statement) or one "camt.052" message (if batch booking breakdown in the "camt.052" is offered by the financial institution).
- **Externally:** Batch booking breakdown externally by referencing a "camt.054" message.

All Swiss financial institutions support internal batch booking breakdown (if the financial institution groups transactions) within a "camt.053" message.

## 9.8 Definitions of specific elements on the basis of camt.053

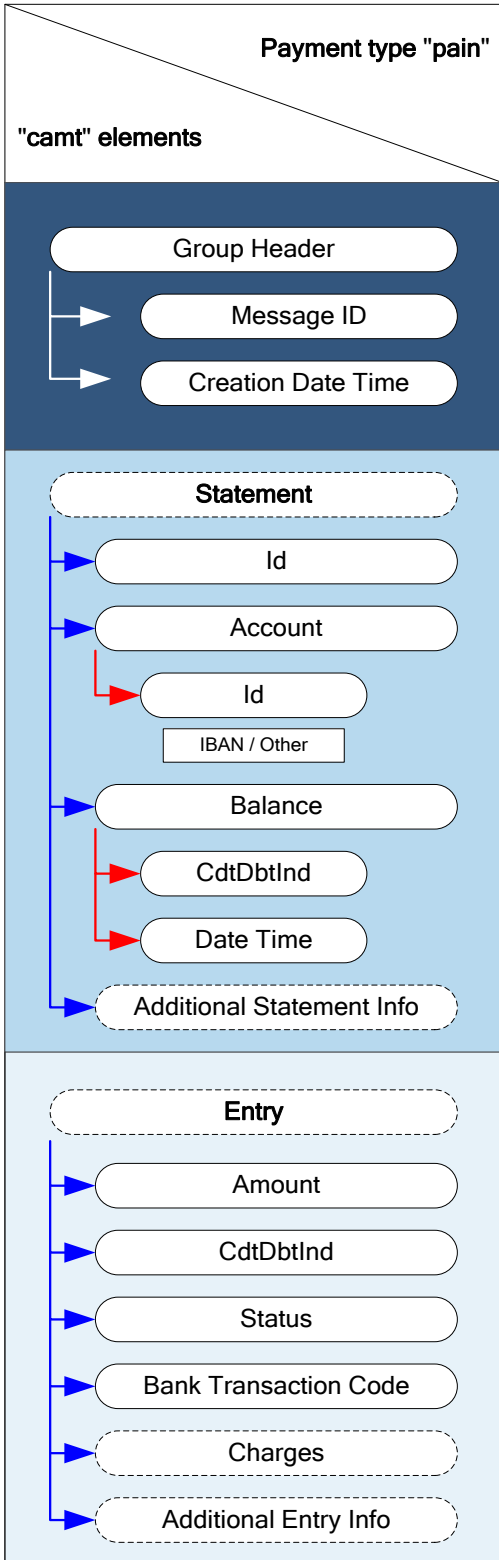

The following remarks on specific elements are based on the "camt.053" message (Customer Statement). Variations from or additions to "camt.052" (Customer Account Report) or "camt.054" (Customer Debit/Credit Notification) messages are explicitly marked as such in the text.

The main elements at A, B and C levels are shown on the left. The following paragraphs describe for each level (including D-Level) the most important elements and how they are used in Switzerland.

**Note:** When "camt" is being introduced, there may be differences during the transitional phase in the degree of detail in the information that is made available, depending on the institution. For all services, the customer can assume that he will receive similar information to that in existing message types (e.g. MT940) in the "camt" messages. In addition, typical ISO elements (e.g. End-to-End ID or the Remittance Information such as the structured ISR reference or the Creditor's Reference) will now also be available.

**9.8.1 Balance <Bal>, B-Level**

---

Information on the account balance.

**9.8.2 Balance Type <Tp>, B-Level**

---

The Balance Type element <BalanceType2Choice> defines the balance type (mandatory field at B-Level). ISO prescribes an external code list. In Switzerland, the following values are used:

Code	Designation (Source: ISO)	Description
CLAV	Closing Available	Value date balance
CLBD	Closing Booked	Closing balance (booking balance)
FWAV	Forward Available	Future value date balance
ITAV	Interim Available	Interim value date balance
ITBD	Interim Booked	Interim booking balance
OPBD	Opening Booked	Opening balance (booking balance)

Table 19: ISO balance codes

**Definitions:**

- Closing Available/Value date balance:  
The value date balance (balance for interest payment purposes) available to an account-holder on the date of the statement.  
Corresponds to Field 64 in the SWIFT MT940/950.
- Closing Booked/Closing balance (booking balance):  
Balance after the booking date, includes all booked transactions (regardless of value date).  
Corresponds to Field 62 in the SWIFT MT940/950.
- Forward Available/Future value date balance  
Value date range in the future  
Corresponds to Field 65 in the SWIFT MT940/950.
- Interim Available/Interim value date balance  
Interim value date balance calculated during the day, may change.  
Corresponds to Field 64 in the SWIFT MT941.
- Interim Booked/Interim booking balance  
Interim booking date calculated during the day, may change.  
Corresponds to Field 62 in the SWIFT MT941.
- Opening Booked/Opening balance (booking balance)  
Opening balance, equates to the closing balance from the previous report.  
Corresponds to Field 60 in the SWIFT MT940/950.

**9.8.3 Entry Status <Sts>, C-Level**

The Entry Status element <EntryStatus2Code> defines the status of a booking (mandatory field at C-Level). ISO prescribes a list of values in the schema. Swiss financial institutions support the following codes.

Code	Designation	Description
BOOK	Booked	Booked turnover
PDNG	Pending	Provisional booking

Table 20: ISO booking status codes

**Definitions:**

- Booked/Booked turnover:  
all booked bookings, i.e. transactions already entered in the end-of-day accounting.
- Pending/Provisional booking  
all provisional bookings, i.e. transactions not yet included in the end-of-day accounting (intraday transactions).

In the "camt.053" message, only "BOOK" is permitted. Status of "camt.052" and "camt.054" see sections 9.9.2 "Entry Status <Sts>, C-Level" and 9.10.3 "Entry Status <Sts>, C-Level".

**9.8.4 Bank Transaction Code <BkTxCd>, C-Level**

The booking type is defined in the Bank Transaction Code <BkTxCd> element (mandatory field at C-Level). This is based on an externally defined ISO Code List. In Switzerland, the current (institute-specific) code is also known as a business transaction code.

See [http://www.iso20022.org/external\\_code\\_list.page](http://www.iso20022.org/external_code_list.page) for ISO codes and Swiss recommendations on Cash Management for the descriptions of selected codes (in the Payments section) which are offered by all institutions in Switzerland.

The ISO Bank Transaction Code is structured as follows:

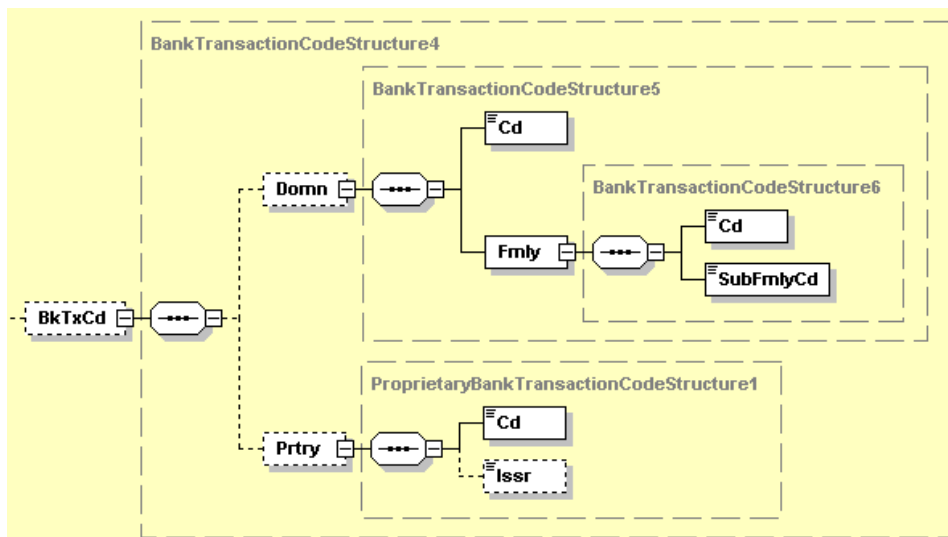

Figure 12: Bank Transaction Code



- Domain:** Highest level of identification. Shows the domain where the booking was entered (e.g. Payments or Cash Management).
- Family:** Describes the transaction type for the booking (e.g. Issued Direct Debits or Account Balancing).
- Sub Family:** Lowest level giving detailed information about the booking (e.g. SEPA Core Direct Debit or Fees).
- Note:** Some institutions also support existing transaction codes (booking code, business transaction code) in the Proprietary field <Prty>.

In the Payments section, the Swiss institutions have agreed to offer a standard code list (a subset of the ISO code list) for entries in these elements (see also the list in Appendix A in the Swiss recommendations on Cash Management). All the codes offered are a valid three-part combination as prescribed by ISO.

**SWIFT MT comment:** Corresponds to Field 61 in MT942, MT940/950: Statement Line (Transaction Type Identification Code), Sub-field 6.

### 9.8.5 References <Refs>, D-Level

---

In Switzerland, the following Transaction Identifications are sent for bookings:

- **MessageIdentification:** Message Identification from the original instruction message (e.g. A-Level from "pain.001" or MT103, Field 20)
- **AccountServicerReference:** Unique reference assigned to the booking by the banking institution. The references can be different at C-Level and D-Level (e.g. when batch bookings are broken down). For individual transactions, the reference is the same.
- **PaymentInformationIdentification:** Identification from the original instruction message (B-Level, e.g. from "pain.001").
- **EndToEndIdentification:** Customer reference for the debtor from the original instruction is sent at all stages (C-Level, e.g. from "pain.001"). According to SWIFT Mapping Rules, this equates to Field 61, Sub-field 7 (Reference Account Owner) in SWIFT MT940.

**Note:** The EndToEndIdentification, as defined by the ISO, is an unstructured element which can be used by the ordering party (pain.001: the debtor, pain.008: the creditor) to identify their transaction uniquely. The ID is unchanged when the message is sent.

**Note:** The structured reference (e.g. the ISR reference or the RF-Creditor's Reference) or the creditor's unstructured reference is sent in the "Remittance Information" element (see section 4.4 "Customer Credit Transfer Initiation references").

Original text ISO: *"Unique identification, as assigned by the initiating party, to unambiguously identify the transaction. This identification is passed on, unchanged, throughout the entire end-to-end chain."*

- **MandateIdentification:** Mandate Identification from the original Direct Debit order (C-Level, from "pain.008").
- **InstructionIdentification:** Identification from the original instruction message (e.g. C-Level from "pain").

The following elements are not used in Switzerland in the current release version:

- **TransactionIdentification**
- **ChequeNumber**
- **ClearingSystemReference**
- **Proprietary**

---

**9.8.6 Bank Transaction Code <BkTxCd>, D-Level**

---

Information about the type of transaction. External code list similar to the element at C-Level (see section 9.8.4 "Bank Transaction Code <BkTxCd>, C-Level"). The code at D-Level may be different from the C-Level, for example in a breakdown of a batch booking (see also the Swiss code list in Appendix A in the Swiss recommendations on Cash Management).

---

**9.8.7 Purpose <Purp>, D-Level**

---

Purpose of the transaction from the original instruction. The purpose (e.g. SALA) may be displayed to the ordering party and the creditor, depending on the continuity of their systems. The codes are managed using an external list (type ExternalPurposeCode, see [www.iso20022.org](http://www.iso20022.org)).

---

**9.8.8 Remittance Information <RmtInf>, D-Level**

---

This field consists of a number of sub-elements. In Switzerland the <CdtrRefInf> field may be filled in, where in the instruction the structured Creditor Reference is given (e.g. ISR reference, IPI reference or the new international Creditor's Reference in accordance with ISO 11649).

**Comment:** The IPI voucher is due to be withdrawn from circulation by 31.03.2020 at the latest.

## 9.9 **Bank to Customer Account Report (camt.052)**

---

This message contains intraday account movements and corresponds to SWIFT messages MT941 and MT942. The customer generally receives these reports at regular intervals (e.g. hourly).

The name and data type for this element is now "**Report**" instead of "Statement". "Report" is used as a component of all sub-fields instead of "Statement" (e.g. also as part of a term such as "Additional **Report** Information" instead of "Additional **Statement** Information"). The structure of the content of this data type is identical except for the features described below.

### 9.9.1 **Balance <Bal>, B-Level**

---

In Switzerland, all movements during the day which have the status "BOOK" or "PNDG" are taken into account when calculating the intraday balance.

### 9.9.2 **Entry Status <Sts>, C-Level**

---

In addition to the expression "BOOK" in "camt.053", in "camt.052" the expression "PNDG" can also be sent.

## 9.10 Bank to Customer Debit Credit Notification (camt.054)

---

The message contains debit and credit notifications and equates to SWIFT messages MT900 and MT910. The customer generally receives these reports subsequent to events (e.g. when an instruction has been placed).

The name and data type of the element it contains is now "**Notification**" instead of "Statement". "Notification" is used as a component of all sub-fields instead of "Statement" (e.g. as part of terms such as "Additional **Notification** Information" instead of "Additional **Statement** Information"). The structure of the content of this data type is identical except for the features described below.

### 9.10.1 Reporting Source <RptgSrc> <Prtry>, B-Level

---

In the "camt.054", the "Reporting Source" element can be delivered as an AOS to distinguish between the different applications of the "camt.054" message.

☒	Additional Optional Service	Explanation
AOS	Element Reporting Source	If delivered, the following possible values can be used: <ul style="list-style-type: none"> <li>• C53F Collective Booking Statement – FI collects Prtry</li> <li>• C53C Collective Booking Statement – Customer collects Prtry</li> <li>• C52F Collective Booking Account Report – FI collects Prtry</li> <li>• C52C Collective Booking Account Report – Customer collects Prtry</li> <li>• DBTN Debit Notification (ISO Code)</li> <li>• CDTN Credit Notification (ISO Code)</li> </ul>

### 9.10.2 Balance <Bal>, B-Level

---

This message does not contain the Balance element.

### 9.10.3 Entry Status <Sts>, C-Level

---

In addition to the expression "BOOK" in "camt.053", in "camt.054" the expression "PNDG" can also be sent.

## Appendix A: Comparison camt.053 – MT940

The following chart shows an example of the how the main objects from SWIFT message MT940 can be mapped on to ISO "camt.053".

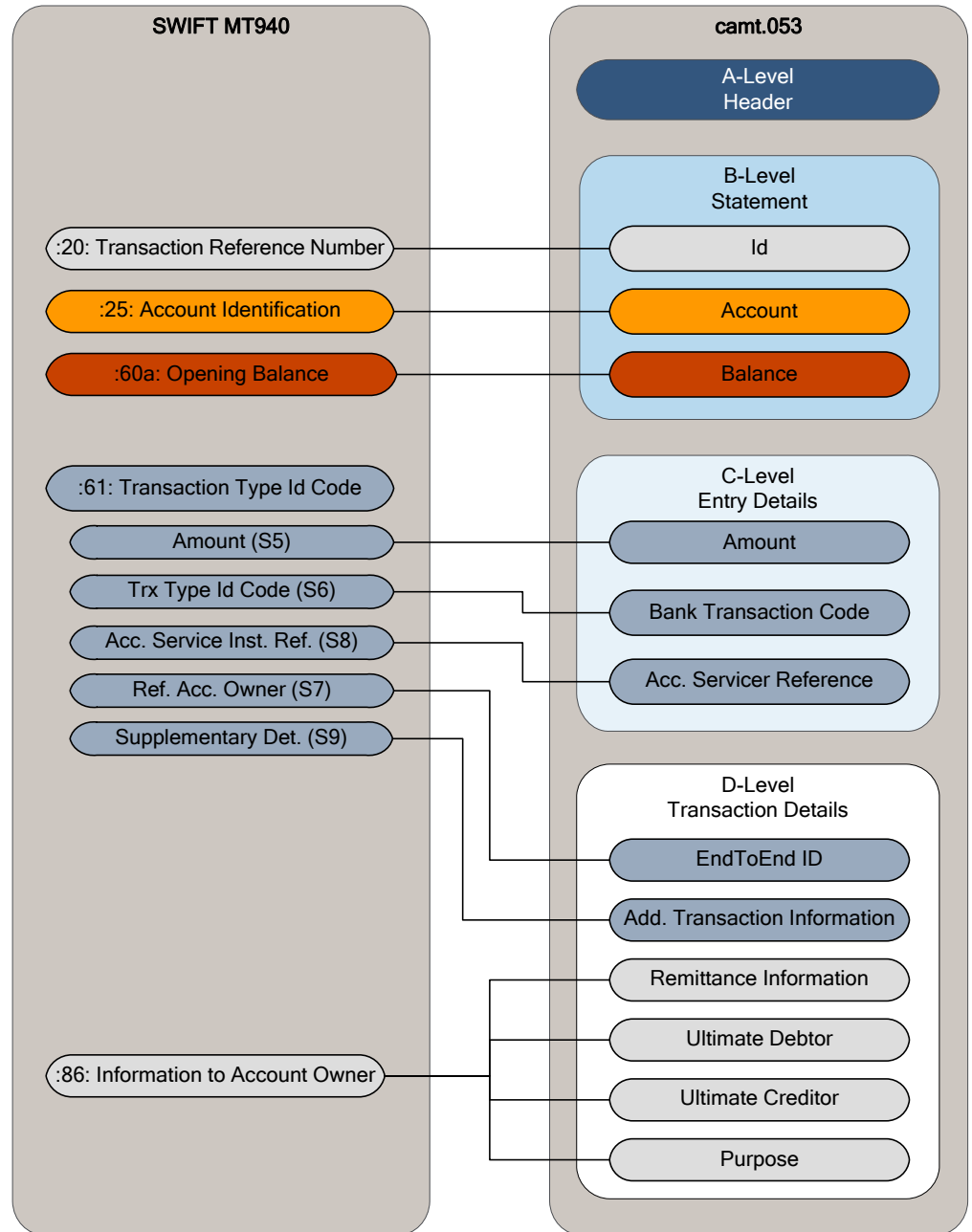

Figure 13: Summary mapping MT940 on to "camt.053"

## Appendix B: References in Cash Management Report

The following chart shows the connection between a payment order and the corresponding bank statements for Debtor and Creditor in summary form. A detailed description of the relationships between the various references can be found in the Implementation Guidelines for "camt" [17].

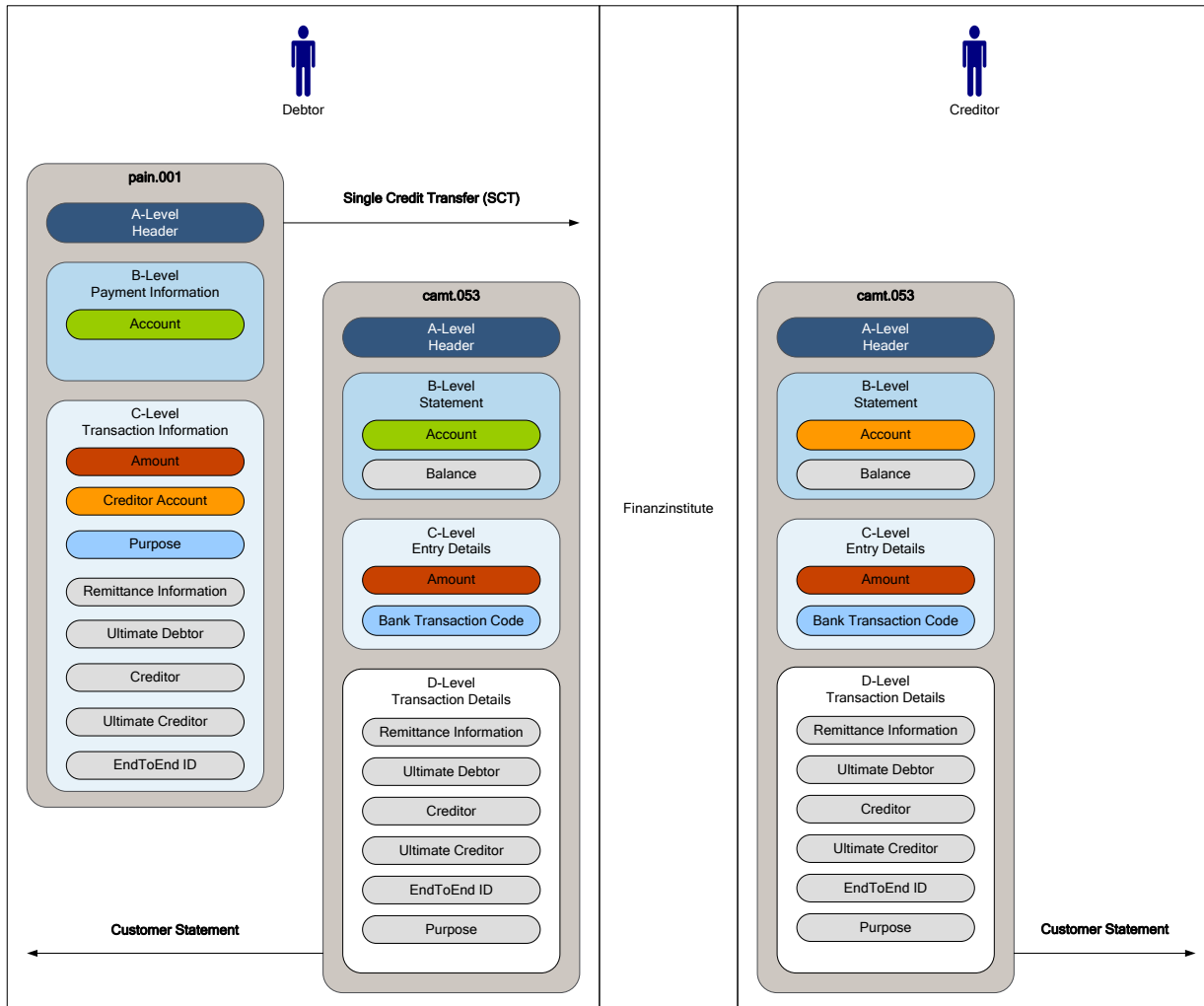

Figure 14: Interaction between "pain.001" and "camt.053"

---

## Appendix C: AOS list

---

Additional participants (e.g. in a multi-banking scenario) .....	20
Batch Booking <BtchBookg> .....	33
Overriding the advice type .....	48
Use of "Instruction for Debtor/ Creditor Agent" for payment types 1, 2.1, 2.2, 3, 5 .....	51
Recipient of the Status Report different from the sender .....	54
Statuses in "pain.002" status reports .....	54
Additional status reports .....	54
Element Reporting Source .....	68

## Appendix D: Basis for the Swiss recommendations

The Swiss recommendations (Business Rules and these Implementation Guidelines) are based on documents from ISO and EPC.

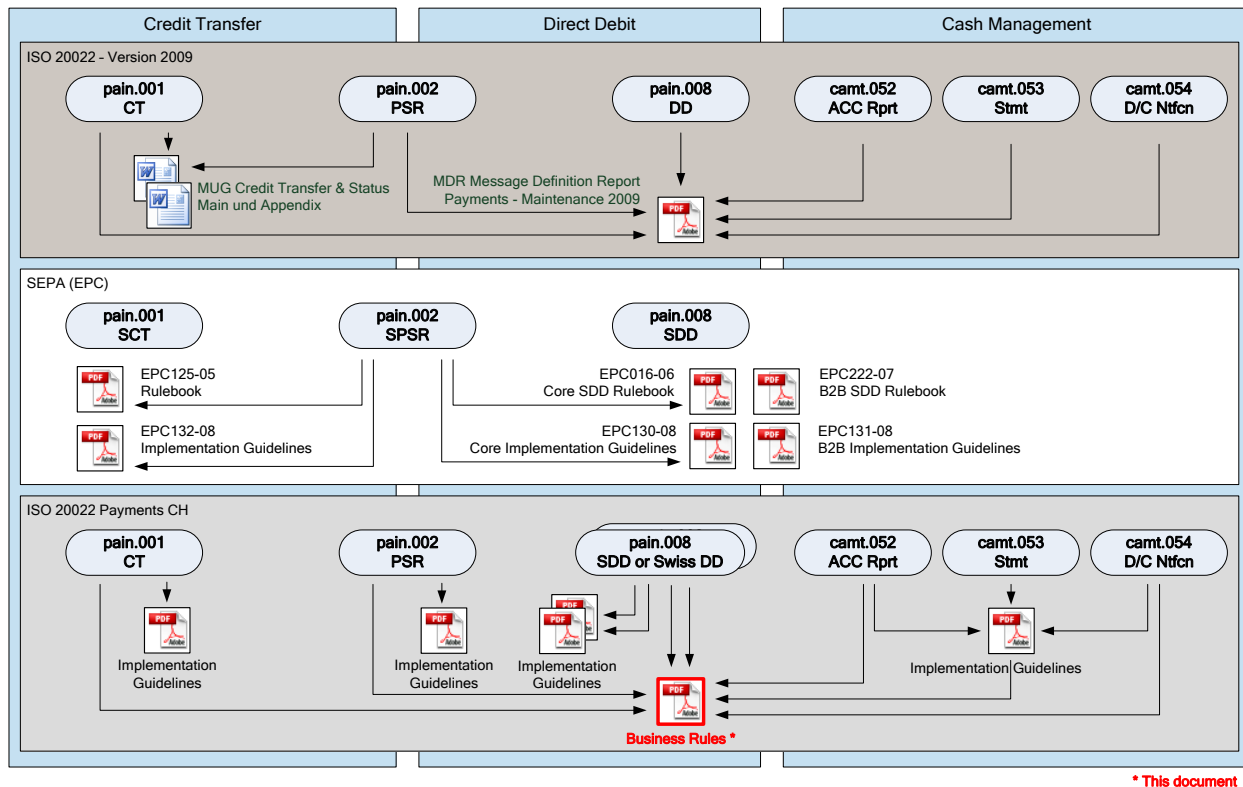

Figure 15: Basis for the Swiss recommendations



## Appendix E: Glossary and list of abbreviations

### ACH

Automated Clearing House (Clearing System)

### Advice, Notification

A distinction is made between credit and debit advices; the term describes a notification from the account-holding institution about a credit or debit to the account-holder's account. Account statements are also described as notifications.

### AOS

Additional Optional Services

### B2B

Expression in the "Local Instrument" element in a Direct Debit message (pain.008) to indicate a SEPA Business-to-Business Direct Debit and a business direct debit in the Swiss-DD system used by PostFinance.

### BIC

Bank Identifier Code (unique international identifier for financial institutions) or, now, Business Identifier Code for non-banks, see also <http://www.swift.com/biconline>

### Booking

The recording of a business transaction on to accounts. Under double accounting, there are always at least two accounts involved in a booking. The booking is made up of at least one debit and at least one credit booking. One booking is always expressed in one booking line.

### Core/Cor1

Expression in the "Local Instrument" element in a Direct Debit message (pain.008) to indicate a SEPA Core Direct Debit (Core) or a basic direct debit in the Swiss-DD system (Cor1).

### CR

Creditor, equates to the beneficiary in the case of Credit Transfer and Direct Debit and is also regarded as the ordering party in the case of Direct Debit.

### CSM

Clearing and Settlement Mechanisms (infrastructure of the settlement systems between banks)

### Confirmation of execution

→ see Status Report

### DEB

(Debtor, equates to the payer in the case of Credit Transfer and Direct Debit and is also regarded as the ordering party in the case of Credit Transfer.

### Document

In ISO, a "document" contains an order from the customer to the bank to carry out 1-n payments. The term is used synonymously with message.

### EPC

European Payments Council – a consortium of banks and bankers' associations from throughout Europe, is the owner of the SEPA schemes and defines the rules for the SEPA Direct Debit Scheme.

### FATF

Financial Action Task Force on Money Laundering. The main aims of the FATF are to develop and promote principles for combating money laundering and the financing of terrorism.

### FC

Foreign currency

### FI

Financial institution (banks and PostFinance)

### IBAN

International Bank Account Number under ISO 13066 (unique international identifier for bank accounts, see also <http://www.europeanpaymentscouncil.eu>)

## ISO

International Organization for Standardization  
(see also <http://www.iso.org>)

## ISO 20022

XML messages complying with the standard of the "ISO 20022 Financial Services – Universal Financial Industry message scheme".

## Message

A message contains one or more payment orders (payments). Under ISO, a payment equates to B-Level with the corresponding debtors, and that in its turn can contain one or more C-Levels (creditors).

## PACS

Payments Clearing & Settlement

## PAIN

Payment Initiation

## Payment

In electronic payment transactions, a payment equates to a payment order (instruction) to a financial institution in favour of a creditor, to hand over a certain sum of money.

## SCT

SEPA Credit Transfer

## SDD

SEPA Direct Debit

## SEPA

Single Euro Payments Area

## SEPA Direct Debit

General term for the two SEPA Direct Debit schemes (core and business-to-business).

## SEPA B2B Direct Debit

Version of direct debit collection for businesses. The B2B version allows for shorter delivery times, but there are stricter conditions for mandate management. Furthermore, there is no right of objection in SEPA B2B Direct Debit.

## SEPA Core Direct Debit

Basic version of a direct debit collection (Direct Debit Initiation, pain.008). In this version, collections which have already been made can be reversed using special procedures (Reject, Return or Refund).

## SEPA Scheme Management

SEPA Scheme Management encompasses the administrative, compliance and development functions relating to a SEPA scheme.

## Service Level Agreements

Agreements between a company that provides services for another company, intended to regulate the duties and responsibilities of each side.

## SKSF

Swiss Commission for Financial Standardisation  
(see also <http://www.sksf.ch>)

## Status Report

Message from the financial institution to the customer about the execution or rejection of payment orders.

## SWIFT

Society for Worldwide Interbank Financial Telecommunication (see also [www.swift.com](http://www.swift.com))

## Transaction

Under ISO, a transaction equates to a payment item at C-Level (creditor). Each item always has its corresponding order at B-Level (debtor).

## UNIFI

UNiversal Financial Industry message scheme

## XML

Extensible Markup Language  
(see also <http://www.w3.org/XML>)

## XSD

XML Schema Definition (Definition of structures for XML documents)

## Appendix F: Table of tables

Table 1:	Reference documents .....	12
Table 2:	Links to Internet pages .....	13
Table 3:	Transactions going to a financial institution in Switzerland .....	15
Table 4:	Transactions going to a financial institution abroad .....	16
Table 5:	Transactions not involving a financial institution in Switzerland or abroad .....	16
Table 6:	Transfer of data from the QR code to the "pain.001" message .....	18
Table 7:	Cash Management messages .....	19
Table 8:	Key elements of Customer Credit Transfer Initiation .....	22
Table 9:	Key elements of Customer Direct Debit Initiation .....	24
Table 10:	Key elements of Payment Status Report .....	26
Table 11:	Key elements of Cash Management message "camt.053" .....	29
Table 12:	Grouping versions ("separate", "grouped", "mixed") .....	31
Table 13:	Customer Credit Transfer Initiation references .....	36
Table 14:	Variants in the case of Customer Direct Debit Initiation references .....	38
Table 15:	Controlling the debit advice .....	46
Table 16:	Cash Management messages .....	58
Table 17:	Optional Cash Management messages .....	59
Table 18:	Versions of Cash Management messages .....	60
Table 19:	ISO balance codes .....	63
Table 20:	ISO booking status codes .....	64

---

## Appendix G: Table of figures

---

Figure 1:	Prototype of the payment slip with reference number and QR code (ISR with QR code) ...	17
Figure 2:	Payment orders under ISO 20022 .....	20
Figure 3:	Message structure Customer Credit Transfer Initiation .....	21
Figure 4:	Message structure Customer Direct Debit Initiation .....	23
Figure 5:	Message structure Payment Status Report .....	25
Figure 6:	Message structure Cash Management messages .....	27
Figure 7:	Grouping versions ("separate", "grouped", "mixed") .....	31
Figure 8:	Batch Booking "FALSE" .....	33
Figure 9:	Batch Booking "TRUE" .....	34
Figure 10:	Customer Credit Transfer references .....	39
Figure 11:	Validation portal customer-bank .....	56
Figure 12:	Bank Transaction Code .....	64
Figure 13:	Summary mapping MT940 on to "camt.053" .....	69
Figure 14:	Interaction between "pain.001" and "camt.053" .....	70
Figure 15:	Basis for the Swiss recommendations .....	72